

ALLEGATO B

Specifiche tecniche per la fornitura delle Dichiarazioni Precompilate 2024

Schema **fornituraP73_2024_v1.xsd**

schema location: **fornituraP73_2024_v1.xsd**
 attributeFormDefault: **unqualified**
 elementFormDefault: **qualified**
 targetNamespace: **urn:www.agenziaentrate.gov.it:specificheTecniche:sco:p73**

Elements Complex types
[Fornitura](#) [Esito Richiesta Type](#)

schema location: **intestazioneP73_2024_v1.xsd**
 attributeFormDefault: **unqualified**
 elementFormDefault: **qualified**
 targetNamespace: **urn:www.agenziaentrate.gov.it:specificheTecniche:sco:p73**

Complex types
[Intestazione P73 Type](#)

schema location: **documentoP73_2024_v1.xsd**
 attributeFormDefault: **unqualified**
 elementFormDefault: **qualified**
 targetNamespace: **urn:www.agenziaentrate.gov.it:specificheTecniche:sco:p73**

Complex types
[Acconti Altri Dati Type](#)
[Acconti Eccedenze Type](#)

[Acconti Irpef Anno Imposta Type](#)
[Acconti Ritenute Type](#)
[Acconti Compensati Intern Type](#)
[Acquisto Costruzione Abit Locazione Addizionali Type](#)
[Altre Detrazioni Type](#)
[Altre Ritenute Type](#)
[Altre Spese Type](#)
[Altri Crediti Imposta Type](#)
[Altri Dati Type](#)
[Altri Oneri Type](#)
[Altri Redditi Ass Lav Type](#)
[Altri Redditi Diversi Detr Type](#)
[Altri Redditi Diversi Type](#)
[Altri Redditi Lavoro Autonomo Type](#)
[Altri Redditi Type](#)
[Altri Redditi Utili Type](#)
[Assegno Coniuge Type](#)
[Casella Acconto Type](#)
[Cedolare Secca Type](#)
[Comparto Sicurezza Type](#)
[Conquaglio Type](#)
[Contributi Previdenza Complementare Type](#)
[Contributo Solidarieta Type](#)
[Cred Erogazione Cultura Type](#)
[Cred Imp Estero Type](#)
[Crediti F24 Type](#)
[Crediti Imposta Altri Sisma Abruzzo Type](#)

Simple types
[Anno Anticipazione Fondo Pensione Type](#)
[Anno Patrimonio Edilizio Situazioni Particolari Type](#)
[e](#)
[Anno Recupero Patrimonio Edilizio Type](#)
[Anno Risparmio Energetico Type](#)
[Casella Codice Type](#)
[Casi Particolari Fabbricato Type](#)
[Casi Particolari Risp Ener Type](#)
[Casi Particolari Terreni Type](#)
[Codice Altre Detrazioni Type](#)
[Codice Altre Spese Type](#)
[Codice Altri Oneri Type](#)
[Codice Canone Type](#)
[Codice Evento Eccezionale Type](#)
[Codice Spese Rateizzate Anni Precedenti Type](#)
[Codice Spese Rateizzate Type](#)
[Fabbricato Agev Numero Rigo Type](#)
[Indeterminato Determinato Type](#)
[Mesi Type](#)
[Numero Rata Risparmio Energetico Type](#)
[Numero Rate5o10 Type](#)
[Periodo Spese Ristrutturazione Type](#)
[Rate10 Type](#)
[Rate5 Type](#)
[Rate Risparmio Energetico Type](#)
[Reintegro Totale Parziale Type](#)
[Rideterminazione Rate Type](#)
[Ripart Risparmio Energetico Type](#)
[Serie Registrazione Contratto Type](#)
[Terreni Urbano Type](#)
[Tipo Inquilino Type](#)

[Crediti Imposta Fabbicati Type](#)
[Crediti Imposta Fondi Pensione Type](#)
[Crediti Imposta Redditi Esteri Type](#)
[Crediti Imposta Type](#)
[Credito Ape](#)
[Credito Erogazioni Cultura Type](#)
[Credito Erogazioni Scuola Type](#)
[Credito Immobile Sisma Abruzzo Type](#)
[Credito Negoziazione Type](#)
[Credito Prima Casa U36](#)
[Credito Stato Type](#)
[Credito Type](#)
[Credito Videosorveglianza Type](#)
[Dati 730 Integrativo Type](#)
[Dati Altre Detrazioni Modulo Type](#)
[Dati Altre Detrazioni Type](#)
[Dati Catastali Recupero Patrimonio Edilizio Type](#)
[Dati Catastali Type](#)
[Dati Coniuge Type](#)
[Dati Contabili Type](#)
[Dati Contratto Type](#)
[Dati F24 Type](#)
[Dati Familiare Type](#)
[Dati Nascita PF Type](#)
[Dati Primo Figlio Type](#)
[Dati Registrazione Accatastamento Recupero Patrimonio Edilizio Type](#)
[Debito Type](#)
[Deduzioni Modulo Type](#)
[Deduzioni Type](#)
[Detrazione Crediti Type](#)
[Detrazioni Canoni Locazione Type](#)
[Detrazioni Modulo Type](#)
[Detrazioni Type](#)
[Documento P73 Type](#)
[Domanda Accatastamento Type](#)
[Domicilio Fiscale Type](#)
[Eccedenze Estero Type](#)
[Eccedenze Oltre Anno Type](#)
[Eccedenze Type](#)
[Elemento Integrativo Type](#)
[Erogazioni Onlus Type](#)
[Esenzione Add Comunale Type](#)
[Esito Liquidazione Type](#)
[Esito Sost Type](#)
[Fabbricato Agev Type](#)
[Fabbricato Ord Type](#)
[Familiari Type](#)
[Tipo Intervento Type](#)
[Tipo Reddito Da1a12 Type](#)
[Tipo Reddito Da1a3 Type](#)
[Tipo Reddito Da1a4 Type](#)
[Tipo Reddito Da1a6 Type](#)
[Tipo Reddito Da1a8 Type](#)
[Tipo Reddito Da1a9 Type](#)
[Titolo Terreno Type](#)
[Utilizzo Fabbricato Type](#)

[Fondo Pensione Dipendenti Pubblici Type](#)
[Frontespizio 730 Type](#)
[Giorni Percentuale Type](#)
[Imposta Lorda Type](#)
[Imposta Netta Type](#)
[Imposte Rimborsate Type](#)
[Incremento Produttività Type](#)
[Inquilini Abitazione Principale Type](#)
[Intervento Recupero Patrimonio Edilizio Type](#)
[Intervento Risparmio Energetico Type](#)
[Investimenti Estero Type](#)
[Investimento Type](#)
[Iva Acquisto Abitazione Type](#)
[Lavoro Dipendente Type](#)
[Locazioni Brevi Type](#)
[Mance Modulo Type](#)
[Mance Type](#)
[Misura Acconti Type](#)
[Modulo Altri Redditi Type](#)
[Modulo Crediti Imposta Type](#)
[Modulo Credito Negoziazione Type](#)
[Modulo Fabbricato Type](#)
[Modulo Familiari Type](#)
[Modulo Investimenti Type](#)
[Modulo Lavoro Dip Type](#)
[Modulo Oneri Type](#)
[Modulo PL Type](#)
[Modulo Terreno Type](#)
[Modulo Ulteriori Dati Type](#)
[N Rate Type](#)
[Oneri Non Abbattuti Type](#)
[Oneri Type](#)
[Opzione Produttività Type](#)
[Periodo Di Lavoro Type](#)
[Premi Risultato Modulo Type](#)
[Premi Risultato Type](#)
[Primo Modulo Acconti Ritenute Type](#)
[Primo Modulo Crediti Imposta Type](#)
[Primo Modulo Familiari Type](#)
[Primo Modulo Investimenti Type](#)
[Primo Modulo Lavoro Dip Type](#)
[Primo Modulo Oneri Type](#)
[Primo Modulo PL Type](#)
[Prospetto Liquidazione Type](#)

[Prospetto Type](#)
[Redditi Capitale Sost Type](#)
[Redditi Capitale Type](#)
[Redditi Eredi Legatari Type](#)
[Redditi Fabbricati Type](#)
[Redditi Lavoro Dip Type](#)
[Redditi Ritenute Spese Type](#)
[Redditi Ritenute Type](#)
[Redditi Tassazione Separata Type](#)
[Redditi Terreni Type](#)
[Reddito Campione Franchi Type](#)
[Reddito Campione Type](#)
[Reddito Erede Type](#)
[Residuo Credito Compens Annolmposta Type](#)
[Residuo Credito Compens Type](#)
[Residuo Fabbricati Type](#)
[Residuo Onlus Type](#)
[Restituzione Somme Type](#)
[Riduzione Pressione Type](#)
[Riepilogo Redditi Type](#)
[Ritenute Acconti Sospesi Type](#)
[Ritenute Lavoro Dip Type](#)
[Rivalutazione Terreni Type](#)
[Sezione Altri Redd Type](#)
[Sezione Dati Catastali Recupero Patrimonio Edilizio Type](#)
[Soggetto Fiscale 730 Type](#)
[Soglie Esenzione Type](#)
[Spese Arredo Giovani Coppie Type](#)
[Spese Arredo Type](#)
[Spese Laurea Ricarica Type](#)
[Spese Leasing Type](#)
[Spese Rateizzate Anni Precedenti Type](#)
[Spese Rateizzate Type](#)
[Tassazione Separata Type](#)
[Terreno Type](#)
[Ulteriori Dati Type](#)

schema location: **sintetico730_2024.xsd**
attributeFormDefault: **unqualified**
elementFormDefault: **qualified**
targetNamespace: **urn:www.agenziaentrate.gov.it:specificheTecniche:sco:p73**

Elements
[ElencoFonti](#)
[Sintetico730](#)

Complex types
[AnagraficaType](#)
[DatiAnagraficiType](#)

Simple types
[DataType](#)
[ImportoType](#)

- [DettaglioFonteType](#)
- [DettaglioType](#)
- [ElencoFontiType](#)
- [FonteType](#)

element **Fornitura**

diagram	
children	p73:Intestazione p73:EsitoRichiesta

element **Fornitura/Intestazione**

diagram	
type	p73:Intestazione P73_Type
children	p73:CodiceFornitura p73:TotaleDocRichiesti p73:TotaleDocForniti p73:TotaleDocScartati p73:TotaleDocNonReperiti

element **Fornitura/EsitoRichiesta**

<p>diagram</p>	
<p>type</p>	<p>p73:Esito_Richiesta_Type</p>
<p>children</p>	<p>p73:CodiceFiscaleRichiesta p73:AnagraficaContribuente p73:DocumentoP73 p73:Sintetico730 p73:Stato</p>

complexType **Esito_Richiesta_Type**

<p>diagram</p>	
<p>children</p>	<p>p73:CodiceFiscaleRichiesta p73:AnagraficaContribuente p73:DocumentoP73 p73:Sintetico730 p73:Stato</p>

element **Esito_Richiesta_Type/CodiceFiscaleRichiesta**

<p>diagram</p>	
----------------	--

element **Esito_Richiesta_Type/AnagraficaContribuente**

<p>diagram</p>	
<p>children</p>	<p>p73:CodiceFiscale p73:Cognome p73:Nome</p>

element **Esito_Richiesta_Type/AnagraficaContribuente/CodiceFiscale**

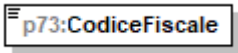
diagram	
type	DatoCF_Type

element **Esito_Richiesta_Type/AnagraficaContribuente/Cognome**

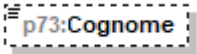
diagram	
type	DatoAN_Type

element **Esito_Richiesta_Type/AnagraficaContribuente/Nome**

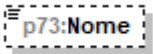
diagram	
type	DatoAN_Type

element **Esito_Richiesta_Type/DocumentoP73**

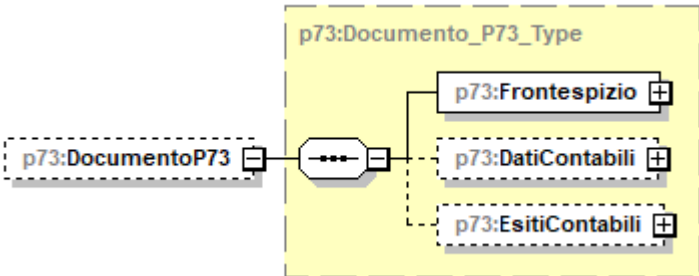
diagram	
type	p73:Documento_P73_Type
children	p73:Frontespizio p73:DatiContabili p73:EsitiContabili

element **Esito_Richiesta_Type/Stato**

diagram	
type	DatoAN_Type

complexType Intestazione_P73_Type

diagram	
children	p73:CodiceFornitura p73:TotaleDocRichiesti p73:TotaleDocForniti p73:TotaleDocScartati p73:TotaleDocNonReperiti

element Intestazione_P73_Type/CodiceFornitura

diagram	
type	restriction of DatoAN_Type

element Intestazione_P73_Type/TotaleDocRichiesti

diagram	
type	DatoNP_Type

element Intestazione_P73_Type/TotaleDocForniti

diagram	
type	DatoNP_Type

element Intestazione_P73_Type/TotaleDocScartati

diagram	
type	DatoNP_Type

element Intestazione_P73_Type/TotaleDocNonReperiti

diagram	
type	DatoNP_Type

complexType Acconti_Altri_Dati_Type

diagram	
children	p73:IncapientiDetrazioneLocazione p73:Pignoramento

element Acconti_Altri_Dati_Type/IncapientiDetrazioneLocazione

diagram	
type	DatoNP_Type

element Acconti_Altri_Dati_Type/Pignoramento

diagram	
children	p73:TipoRedditoPignoramento p73:RitenutePignoramento

element Acconti_Altri_Dati_Type/Pignoramento/TipoRedditoPignoramento

diagram															
type	restriction of DatoN1_Type														
facets	<table border="1"> <thead> <tr> <th>Kind</th> <th>Value</th> </tr> </thead> <tbody> <tr> <td>enumeration</td> <td>1</td> </tr> <tr> <td>enumeration</td> <td>2</td> </tr> <tr> <td>enumeration</td> <td>3</td> </tr> <tr> <td>enumeration</td> <td>4</td> </tr> <tr> <td>enumeration</td> <td>5</td> </tr> <tr> <td>enumeration</td> <td>6</td> </tr> </tbody> </table>	Kind	Value	enumeration	1	enumeration	2	enumeration	3	enumeration	4	enumeration	5	enumeration	6
Kind	Value														
enumeration	1														
enumeration	2														
enumeration	3														
enumeration	4														
enumeration	5														
enumeration	6														

element Acconti_Altri_Dati_Type/Pignoramento/RitenutePignoramento

diagram	
type	DatoNP_Type

complexType Acconti_Eccedenze_Type

<p>diagram</p>	
<p>children</p>	<p>p73:EccedenzaPrecDic p73:EccedenzaCompensata p73:AccontiVersati p73:EccedenzaVersamento</p>

element Acconti_Eccedenze_Type/EccedenzaPrecDic

<p>diagram</p>	
<p>type</p>	<p>DatoNP_Type</p>

element Acconti_Eccedenze_Type/EccedenzaCompensata

<p>diagram</p>	
<p>type</p>	<p>DatoNP_Type</p>

element Acconti_Eccedenze_Type/AccontiVersati

<p>diagram</p>	
<p>type</p>	<p>DatoNP_Type</p>

element Acconti_Eccedenze_Type/EccedenzaVersamento

<p>diagram</p>	
<p>type</p>	<p>DatoNP_Type</p>

complexType Acconti_Irpef_Anno_Imposta_Type

<p>diagram</p>	
<p>children</p>	<p>p73:PrimaRataAccontolrpef p73:SecondaRataAccontolrpef p73:AccontoAddComunale p73:PrimaRataAccontoCedolare p73:SecondaRataAccontoCedolare</p>

element Acconti_Irpef_Anno_Imposta_Type/PrimaRataAccontolrpef

<p>diagram</p>	
<p>type</p>	<p>DatoNP_Type</p>

element Acconti_Irpef_Anno_Imposta_Type/SecondaRataAccontolrpef

<p>diagram</p>	
<p>type</p>	<p>DatoNP_Type</p>

element Acconti_Irpef_Anno_Imposta_Type/AccontoAddComunale

<p>diagram</p>	
<p>type</p>	<p>DatoNP_Type</p>

element Acconti_Irpef_Anno_Imposta_Type/PrimaRataAccontoCedolare

<p>diagram</p>	
<p>type</p>	<p>DatoNP_Type</p>

element Acconti_Irpef_Anno_Imposta_Type/SecondaRataAccontoCedolare

<p>diagram</p>	
<p>type</p>	<p>DatoNP_Type</p>

complexType Acconti_Ritenute_Type

<p>diagram</p>	
<p>children</p>	<p>p73:PrimoModulo p73:Modulo</p>

element Acconti_Ritenute_Type/PrimoModulo

<p>diagram</p>	
<p>type</p>	<p>p73:Primo Modulo Acconti Ritenute Type</p>
<p>children</p>	<p>p73:Accontilrpef p73:AltreRitenute p73:Eccedenze p73:EccedenzeOltreAnno p73:RitenuteAccontiSospesi p73:MisuraAcconti p73:EsenzioneAddComunale p73:Dati730Integrativo p73:AccontiAltriDati p73:LocazioniBrevi</p>

element Acconti_Ritenute_Type/Modulo

<p>diagram</p>	
----------------	--

children	p73:AltreRitenute p73:EccedenzeOltreAnno p73:Pignoramento
----------	---

element **Acconti_Ritenute_Type/Modulo/AltreRitenute**

diagram	<pre> classDiagram class p73AltreRitenute_Type { p73:Codice p73:AltreRitenuteIrpef p73:AddizionaleRegionale p73:AddizionaleComunale p73:AddRegionaleIrpefAttivitaSp... p73:AddComunaleIrpefAttivitaS... p73:IrpefLavoriSocialmenteUtili p73:AddRegionaleIrpefLavoriSo... } class p73AltreRitenute p73AltreRitenute_Type "1" -- "*" p73AltreRitenute </pre>
type	p73:Altre_Ritenute_Type
children	p73:Codice p73:AltreRitenuteIrpef p73:AddizionaleRegionale p73:AddizionaleComunale p73:AddRegionaleIrpefAttivitaSport p73:AddComunaleIrpefAttivitaSport p73:IrpefLavoriSocialmenteUtili p73:AddRegionaleIrpefLavoriSoc Utili

element **Acconti_Ritenute_Type/Modulo/EccedenzeOltreAnno**

diagram	
type	p73:Eccedenze_Oltre_Anno_Type
children	p73:Anno p73:Irpef p73:SostitutivaQuadroRT p73:CedolareSecca p73:CodiceRegione p73:AddRegionaleIrpef p73:CodiceCatastaleComune p73:AddComunaleIrpef p73:ImpostaSostitutiva

element **Acconti_Ritenute_Type/Modulo/Pignoramento**

diagram	
children	p73:TipoRedditoPignoramento p73:RitenutePignoramento

element **Acconti_Ritenute_Type/Modulo/Pignoramento/TipoRedditoPignoramento**

diagram															
type	restriction of DatoN1_Type														
facets	<table border="1"> <thead> <tr> <th>Kind</th> <th>Value</th> </tr> </thead> <tbody> <tr> <td>enumeration</td> <td>1</td> </tr> <tr> <td>enumeration</td> <td>2</td> </tr> <tr> <td>enumeration</td> <td>3</td> </tr> <tr> <td>enumeration</td> <td>4</td> </tr> <tr> <td>enumeration</td> <td>5</td> </tr> <tr> <td>enumeration</td> <td>6</td> </tr> </tbody> </table>	Kind	Value	enumeration	1	enumeration	2	enumeration	3	enumeration	4	enumeration	5	enumeration	6
Kind	Value														
enumeration	1														
enumeration	2														
enumeration	3														
enumeration	4														
enumeration	5														
enumeration	6														

element **Acconti_Ritenute_Type/Modulo/Pignoramento/RitenutePignoramento**

diagram	
type	DatoNP_Type

complexType **Acoonti_Compensati_Intern_Type**

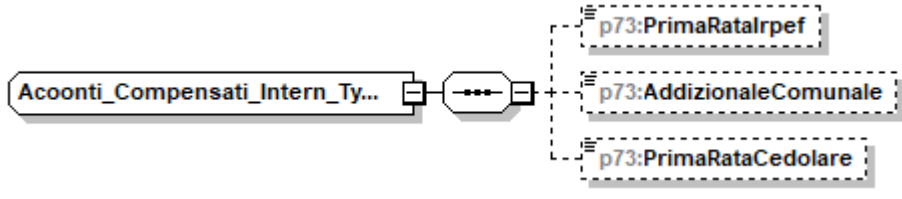
diagram	
children	p73:PrimaRatalrpef p73:AddizionaleComunale p73:PrimaRataCedolare

element **Acoonti_Compensati_Intern_Type/PrimaRatalrpef**

diagram	
type	DatoNP_Type

element **Acoonti_Compensati_Intern_Type/AddizionaleComunale**

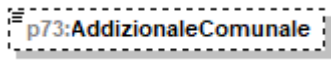
diagram	
type	DatoNP_Type

element **Acoonti_Compensati_Intern_Type/PrimaRataCedolare**

diagram	
type	DatoNP_Type

complexType **Acquisto_Costruzione_Abit_Locazione**

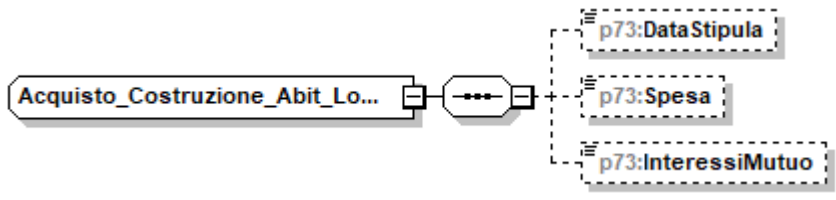
diagram	
children	p73:DataStipula p73:Spesa p73:InteressiMutuo

element **Acquisto_Costruzione_Abit_Locazione/DataStipula**

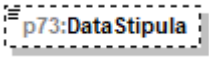
diagram	
type	DatoDT_Type

element **Acquisto_Costruzione_Abit_Locazione/Spesa**

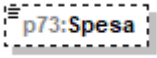
diagram	
type	DatoNP_Type

element **Acquisto_Costruzione_Abit_Locazione/InteressiMutuo**

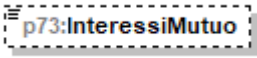
diagram	
type	DatoNP_Type

complexType **Addizionali_Type**

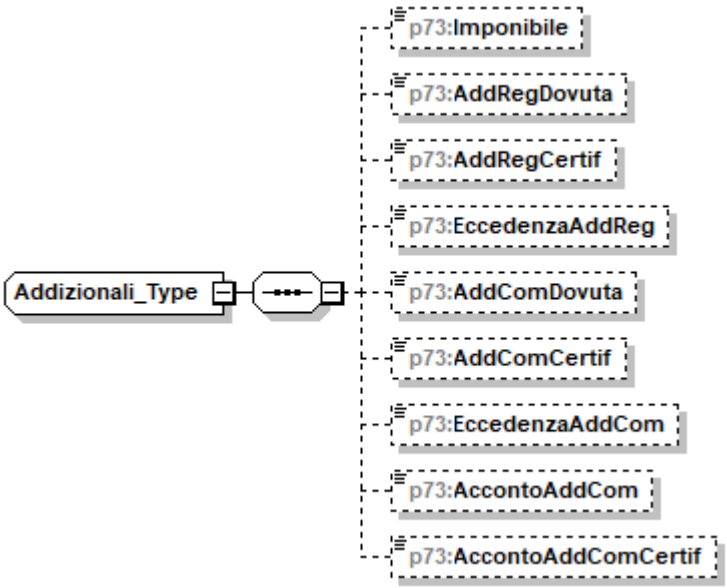
diagram	
children	p73:Imponibile p73:AddRegDovuta p73:AddRegCertif p73:EccedenzaAddReg p73:AddComDovuta p73:AddComCertif p73:EccedenzaAddCom p73:AccontoAddCom p73:AccontoAddComCertif

element **Addizionali_Type/Imponibile**

diagram	
type	DatoNP_Type

element **Addizionali_Type/AddRegDovuta**

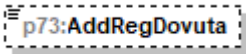
diagram	
type	DatoNP_Type

element **Addizionali_Type/AddRegCertif**

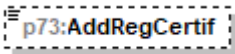
diagram	
type	DatoNP_Type

element **Addizionali_Type/EccedenzaAddReg**

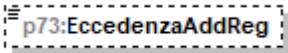
diagram	
type	DatoNU_Type

element **Addizionali_Type/AddComDovuta**

diagram	
type	DatoNP_Type

element **Addizionali_Type/AddComCertif**

diagram	
type	DatoNP_Type

element **Addizionali_Type/EccedenzaAddCom**

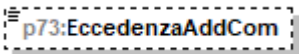
diagram	
type	DatoNU_Type

element **Addizionali_Type/AcontoAddCom**

diagram	
type	DatoNP_Type

element **Addizionali_Type/AcontoAddComCertif**

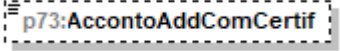
diagram	
type	DatoNP_Type

complexType **Altre_Detrazioni_Type**

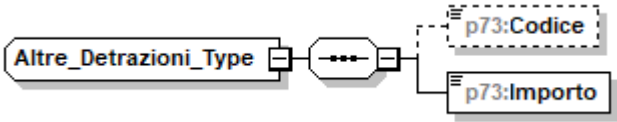
diagram	
children	p73:Codice p73:Importo

element **Altre_Detrazioni_Type/Codice**

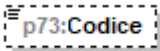
diagram							
type	p73:Codice Altre_Detrazioni_Type						
facets	<table border="1"> <thead> <tr> <th>Kind</th> <th>Value</th> </tr> </thead> <tbody> <tr> <td>enumeration</td> <td>1</td> </tr> <tr> <td>enumeration</td> <td>2</td> </tr> </tbody> </table>	Kind	Value	enumeration	1	enumeration	2
Kind	Value						
enumeration	1						
enumeration	2						

element **Altre_Detrazioni_Type/Importo**

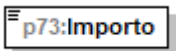
diagram	
type	DatoNP_Type

complexType **Altre_Ritenute_Type**

<p>diagram</p>	
<p>children</p>	<p>p73:Codice p73:AltreRitenuteIrpef p73:AddizionaleRegionale p73:AddizionaleComunale p73:AddRegionaleIrpefAttivitaSport p73:AddComunaleIrpefAttivitaSport p73:IrpefLavoriSocialmenteUtili p73:AddRegionaleIrpefLavoriSoc Utili</p>

element **Altre_Ritenute_Type/Codice**

<p>diagram</p>							
<p>type</p>	<p>restriction of DatoN1_Type</p>						
<p>facets</p>	<table border="1"> <thead> <tr> <th>Kind</th> <th>Value</th> </tr> </thead> <tbody> <tr> <td>enumeration</td> <td>1</td> </tr> <tr> <td>enumeration</td> <td>2</td> </tr> </tbody> </table>	Kind	Value	enumeration	1	enumeration	2
Kind	Value						
enumeration	1						
enumeration	2						

element **Altre_Ritenute_Type/AltreRitenuteIrpef**

<p>diagram</p>	
<p>type</p>	<p>DatoNP_Type</p>

element **Altre_Ritenute_Type/AddizionaleRegionale**

<p>diagram</p>	
<p>type</p>	<p>DatoNP_Type</p>

element **Altre_Ritenute_Type/AddizionaleComunale**

diagram	
type	DatoNP_Type

element **Altre_Ritenute_Type/AddRegionaleIrpefAttivitaSport**

diagram	
type	DatoNP_Type

element **Altre_Ritenute_Type/AddComunaleIrpefAttivitaSport**

diagram	
type	DatoNP_Type

element **Altre_Ritenute_Type/IrpefLavoriSocialmenteUtili**

diagram	
type	DatoNP_Type

element **Altre_Ritenute_Type/AddRegionaleIrpefLavoriSoc_Utili**

diagram	
type	DatoNP_Type

complexType **Altre_Spese_Type**

diagram	
children	p73:Codice p73:Importo

element **Altre_Spese_Type/Codice**

diagram	
---------	--

type	p73:Codice_Altre_Spese_Type	
facets	Kind	Value
	enumeration	8
	enumeration	9
	enumeration	10
	enumeration	11
	enumeration	12
	enumeration	13
	enumeration	14
	enumeration	15
	enumeration	16
	enumeration	17
	enumeration	18
	enumeration	20
	enumeration	21
	enumeration	22
	enumeration	24
	enumeration	25
	enumeration	26
	enumeration	27
	enumeration	28
	enumeration	29
	enumeration	30
	enumeration	31
	enumeration	32
	enumeration	33
	enumeration	35
	enumeration	36
	enumeration	38
	enumeration	39
	enumeration	40
	enumeration	43
	enumeration	44
	enumeration	45
	enumeration	46
	enumeration	47
	enumeration	61
	enumeration	62
	enumeration	71
	enumeration	76
	enumeration	81
	enumeration	99

element **Altre_Spese_Type/Importo**

diagram	
type	DatoNP_Type

complexType Altri_Crediti_Imposta_Type

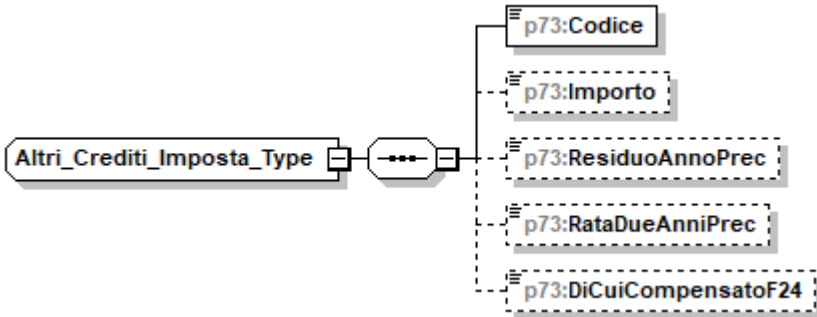
diagram	
children	p73:Codice p73:Importo p73:ResiduoAnnoPrec p73:RataDueAnniPrec p73:DiCuiCompensatoF24

element Altri_Crediti_Imposta_Type/Codice

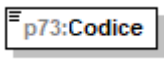
diagram	
type	restriction of DatoNP_Type

element Altri_Crediti_Imposta_Type/Importo

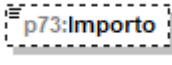
diagram	
type	restriction of DatoNP_Type

element Altri_Crediti_Imposta_Type/ResiduoAnnoPrec

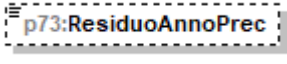
diagram	
type	restriction of DatoNP_Type

element Altri_Crediti_Imposta_Type/RataDueAnniPrec

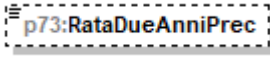
diagram	
type	restriction of DatoNP_Type

element Altri_Crediti_Imposta_Type/DiCuiCompensatoF24

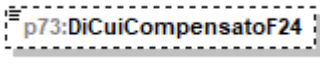
diagram	
type	restriction of DatoNP_Type

complexType Altri_Dati_Type

diagram	
---------	---

complexType Altri_Oneri_Type

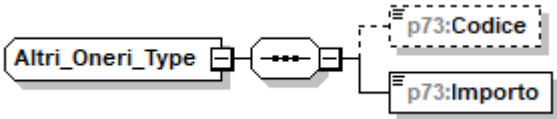
diagram	
children	p73:Codice p73:Importo

element Altri_Oneri_Type/Codice

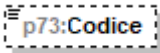
diagram																	
type	p73:Codice Altri_Oneri_Type																
facets	<table border="1"> <thead> <tr> <th>Kind</th> <th>Value</th> </tr> </thead> <tbody> <tr> <td>enumeration</td> <td>6</td> </tr> <tr> <td>enumeration</td> <td>7</td> </tr> <tr> <td>enumeration</td> <td>8</td> </tr> <tr> <td>enumeration</td> <td>9</td> </tr> <tr> <td>enumeration</td> <td>12</td> </tr> <tr> <td>enumeration</td> <td>13</td> </tr> <tr> <td>enumeration</td> <td>21</td> </tr> </tbody> </table>	Kind	Value	enumeration	6	enumeration	7	enumeration	8	enumeration	9	enumeration	12	enumeration	13	enumeration	21
Kind	Value																
enumeration	6																
enumeration	7																
enumeration	8																
enumeration	9																
enumeration	12																
enumeration	13																
enumeration	21																

element Altri_Oneri_Type/Importo

diagram	
type	DatoNP_Type

complexType Altri_Redditi_Ass_Lav_Type

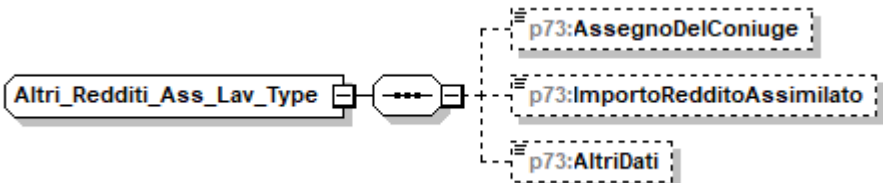
diagram	
children	p73:AssegnoDelConiuge p73:ImportoRedditoAssimilato p73:AltriDati

element **Altri_Reddito_Ass_Lav_Type/AssegnoDelConiuge**

diagram	
type	DatoCB_Type

element **Altri_Reddito_Ass_Lav_Type/ImportoRedditoAssimilato**

diagram	
type	DatoNP_Type

element **Altri_Reddito_Ass_Lav_Type/AltriDati**

diagram							
type	restriction of DatoNP_Type						
facets	<table border="1"> <thead> <tr> <th>Kind</th> <th>Value</th> </tr> </thead> <tbody> <tr> <td>enumeration</td> <td>1</td> </tr> <tr> <td>enumeration</td> <td>5</td> </tr> </tbody> </table>	Kind	Value	enumeration	1	enumeration	5
Kind	Value						
enumeration	1						
enumeration	5						

complexType **Altri_Reddito_Diversi_Detr_Type**

diagram	
children	p73:AltriDati p73:Tipo_Reddito p73:RedditiRitenuteSpese

element **Altri_Reddito_Diversi_Detr_Type/AltriDati**

diagram					
type	restriction of DatoNP_Type				
facets	<table border="1"> <thead> <tr> <th>Kind</th> <th>Value</th> </tr> </thead> <tbody> <tr> <td>enumeration</td> <td>5</td> </tr> </tbody> </table>	Kind	Value	enumeration	5
Kind	Value				
enumeration	5				

element **Altri_Reddito_Diversi_Detr_Type/Tipo_Reddito**

diagram	
type	restriction of DatoNP_Type

facets	Kind	Value
	enumeration	1
	enumeration	2
	enumeration	3
	enumeration	4
	enumeration	5

element **Altri_Reddito_Diversi_Detr_Type/RedditiRitenuteSpese**

diagram	
type	p73:Redditi_Ritenute_Spese_Type
children	p73:ImportoRedditi p73:ImportoRitenute p73:ImportoSpese

complexType **Altri_Reddito_Diversi_Type**

diagram	
children	p73:CedolareSecca p73:TipoReddito p73:RedditiRitenuteSpese

element **Altri_Reddito_Diversi_Type/CedolareSecca**

diagram	
type	DatoCB_Type

element **Altri_Reddito_Diversi_Type/TipoReddito**

diagram		
type	restriction of DatoNP_Type	
facets	Kind	Value
	enumeration	1
	enumeration	2
	enumeration	3
	enumeration	4
	enumeration	5

enumeration	6
enumeration	7
enumeration	8
enumeration	9
enumeration	10
enumeration	11
enumeration	12
enumeration	13

element **Altri_Reddito_Diversi_Type/RedditoRitenuteSpese**

diagram	
type	p73:RedditoRitenuteSpese_Type
children	p73:ImportoReddito p73:ImportoRitenute p73:ImportoSpese

complexType **Altri_Reddito_Lavoro_Autonomo_Type**

diagram	
children	p73:AltriDati p73:TipoReddito p73:RedditoRitenute

element **Altri_Reddito_Lavoro_Autonomo_Type/AltriDati**

diagram	
type	restriction of DatoNP_Type
facets	Kind Value enumeration 5

element **Altri_Reddito_Lavoro_Autonomo_Type/TipoReddito**

diagram	
type	restriction of DatoNP_Type
facets	Kind Value enumeration 1

	enumeration 2
	enumeration 3
	enumeration 4
	enumeration 5

element **Altri_Reddi_Lavoro_Autonomo_Type/RedditiRitenute**

diagram	
type	p73:Redditi_Ritenute_Type
children	p73:ImportoRedditi p73:ImportoRitenute

complexType **Altri_Reddi_Type**

diagram	
children	p73:Modulo

element **Altri_Reddi_Type/Modulo**

diagram	
type	p73:Modulo_Altri_Reddi_Type
children	p73:RedditiDiCapitale p73:RedditiTassazioneSeparata

complexType **Altri_Reddi_Utili_Type**

diagram	
children	p73:Tipo_Reddito p73:RedditiRitenute

element **Altri_Reddito_Utili_Type/Tipo_Reddito**

diagram																									
type	restriction of DatoNP_Type																								
facets	<table border="1"> <thead> <tr> <th>Kind</th> <th>Value</th> </tr> </thead> <tbody> <tr><td>enumeration</td><td>1</td></tr> <tr><td>enumeration</td><td>2</td></tr> <tr><td>enumeration</td><td>3</td></tr> <tr><td>enumeration</td><td>4</td></tr> <tr><td>enumeration</td><td>5</td></tr> <tr><td>enumeration</td><td>6</td></tr> <tr><td>enumeration</td><td>7</td></tr> <tr><td>enumeration</td><td>8</td></tr> <tr><td>enumeration</td><td>9</td></tr> <tr><td>enumeration</td><td>10</td></tr> <tr><td>enumeration</td><td>11</td></tr> </tbody> </table>	Kind	Value	enumeration	1	enumeration	2	enumeration	3	enumeration	4	enumeration	5	enumeration	6	enumeration	7	enumeration	8	enumeration	9	enumeration	10	enumeration	11
Kind	Value																								
enumeration	1																								
enumeration	2																								
enumeration	3																								
enumeration	4																								
enumeration	5																								
enumeration	6																								
enumeration	7																								
enumeration	8																								
enumeration	9																								
enumeration	10																								
enumeration	11																								

element **Altri_Reddito_Utili_Type/RedditiRitenute**

diagram	
type	p73:Redditi_Ritenute_Type
children	p73:ImportoRedditi p73:ImportoRitenute

complexType **Assegno_Coniuge_Type**

diagram	
children	p73:CodiceFiscale p73:Importo

element **Assegno_Coniuge_Type/CodiceFiscale**

diagram	
type	DatoCF_Type

element **Assegno_Coniuge_Type/Importo**

diagram	
---------	--

type	DatoNP_Type
------	-----------------------------

complexType Casella_Acconto_Type

diagram	
children	p73:Casella p73:ImportoMisuralInferiore

element Casella_Acconto_Type/Casella

diagram	
type	DatoCB_Type

element Casella_Acconto_Type/ImportoMisuralInferiore

diagram	
type	DatoNP_Type

complexType Cedolare_Secca_Type

diagram	
children	p73:CedolareDovuta p73:EccedenzaCedolareSecca p73:AccontoCedolare

element Cedolare_Secca_Type/CedolareDovuta

diagram	
type	DatoNP_Type

element Cedolare_Secca_Type/EccedenzaCedolareSecca

diagram	
---------	--

type	DatoNU_Type
------	-----------------------------

element **Cedolare_Secca_Type/AcontoCedolare**

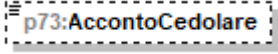
diagram	
type	DatoNP_Type

complexType **Comparto_Sicurezza_Type**

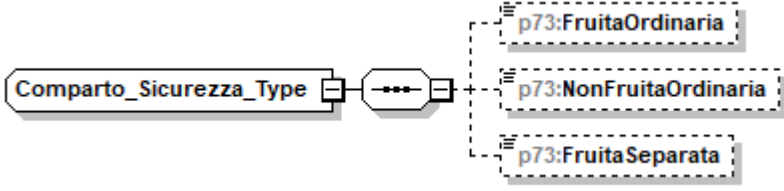
diagram	
children	p73:FruitaOrdinaria p73:NonFruitaOrdinaria p73:FruitaSeparata

element **Comparto_Sicurezza_Type/FruitaOrdinaria**

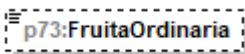
diagram	
type	DatoNP_Type

element **Comparto_Sicurezza_Type/NonFruitaOrdinaria**

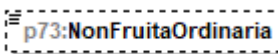
diagram	
type	DatoNP_Type

element **Comparto_Sicurezza_Type/FruitaSeparata**

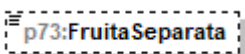
diagram	
type	DatoNP_Type

complexType **Conguaglio_Type**

<p>diagram</p>	
<p>children</p>	<p>p73:NumeroRate p73:ImportoTrattenutoSaldo p73:ImportoTrattenutoAcconto p73:ImportoDaVersareF24Saldo p73:ImportoDaVersareF24Acconto p73:ImportoRimborsato p73:ImportoRimborsatoAgenzia p73:OpzioneInformativa</p>

element **Conguaglio_Type/NumeroRate**

<p>diagram</p>															
<p>type</p>	<p>restriction of DatoN1_Type</p>														
<p>facets</p>	<table border="1"> <thead> <tr> <th>Kind</th> <th>Value</th> </tr> </thead> <tbody> <tr> <td>enumeration</td> <td>2</td> </tr> <tr> <td>enumeration</td> <td>3</td> </tr> <tr> <td>enumeration</td> <td>4</td> </tr> <tr> <td>enumeration</td> <td>5</td> </tr> <tr> <td>enumeration</td> <td>6</td> </tr> <tr> <td>enumeration</td> <td>7</td> </tr> </tbody> </table>	Kind	Value	enumeration	2	enumeration	3	enumeration	4	enumeration	5	enumeration	6	enumeration	7
Kind	Value														
enumeration	2														
enumeration	3														
enumeration	4														
enumeration	5														
enumeration	6														
enumeration	7														

element **Conguaglio_Type/ImportoTrattenutoSaldo**

<p>diagram</p>	
<p>type</p>	<p>DatoNP_Type</p>

element **Conguaglio_Type/ImportoTrattenutoAcconto**

<p>diagram</p>	
<p>type</p>	<p>DatoNP_Type</p>

element **Conguaglio_Type/ImportoDaVersareF24Saldo**

diagram	
type	DatoNP_Type

element **Conguaglio_Type/ImportoDaVersareF24Acconto**

diagram	
type	DatoNP_Type

element **Conguaglio_Type/ImportoRimborsato**

diagram	
type	DatoNP_Type

element **Conguaglio_Type/ImportoRimborsatoAgenzia**

diagram	
type	DatoNP_Type

element **Conguaglio_Type/OpzioneInformativa**

diagram	
type	DatoCB_Type

complexType **Contributi_Previdenza_Complementare_Type**

diagram	
children	p73:EsclusiDalSostituto p73:NonEsclusiDalSostituto

element **Contributi_Previdenza_Complementare_Type/EsclusiDalSostituto**

diagram	
---------	--

type	DatoNP_Type
------	-----------------------------

element **Contributi_Previdenza_Complementare_Type/NonEsclusiDalSostituto**

diagram	
type	DatoNP_Type

complexType **Contributo_Solidarieta_Type**

diagram	
children	p73:ImponibileContributo p73:ContributoDovuto p73:ContributoCertificaz

element **Contributo_Solidarieta_Type/ImponibileContributo**

diagram	
type	DatoNP_Type

element **Contributo_Solidarieta_Type/ContributoDovuto**

diagram	
type	DatoNP_Type

element **Contributo_Solidarieta_Type/ContributoCertificaz**

diagram	
type	DatoNP_Type

complexType **Cred_Erogazione_Cultura_Type**

diagram	
---------	--

children	p73:RataAnnoPrec p73:RataAnno
----------	---

element Cred_Erogazione_Cultura_Type/RataAnnoPrec

diagram	
type	DatoNP_Type

element Cred_Erogazione_Cultura_Type/RataAnno

diagram	
type	DatoNP_Type

complexType Cred_Imp_Estero_Type

diagram	
children	p73:Anno p73:TotCredito p73:CreditoStato

element Cred_Imp_Estero_Type/Anno

diagram	
type	DatoDA_Type

element Cred_Imp_Estero_Type/TotCredito

diagram	
type	DatoNP_Type

element **Cred_Imp_Estero_Type/CreditoStato**

<p>diagram</p>	<p>The diagram illustrates the structure of the p73:CreditoStato element. It is shown as a class with a multiplicity of 1..2. This class is connected to a container element, p73:Credito_Stato_Type, which is highlighted with a yellow dashed border. Inside this container, there are two child elements: p73:Stato and p73:Credito.</p>
<p>type</p>	<p>p73:Credito_Stato_Type</p>
<p>children</p>	<p>p73:Stato p73:Credito</p>

complexType **Crediti_F24_Type**

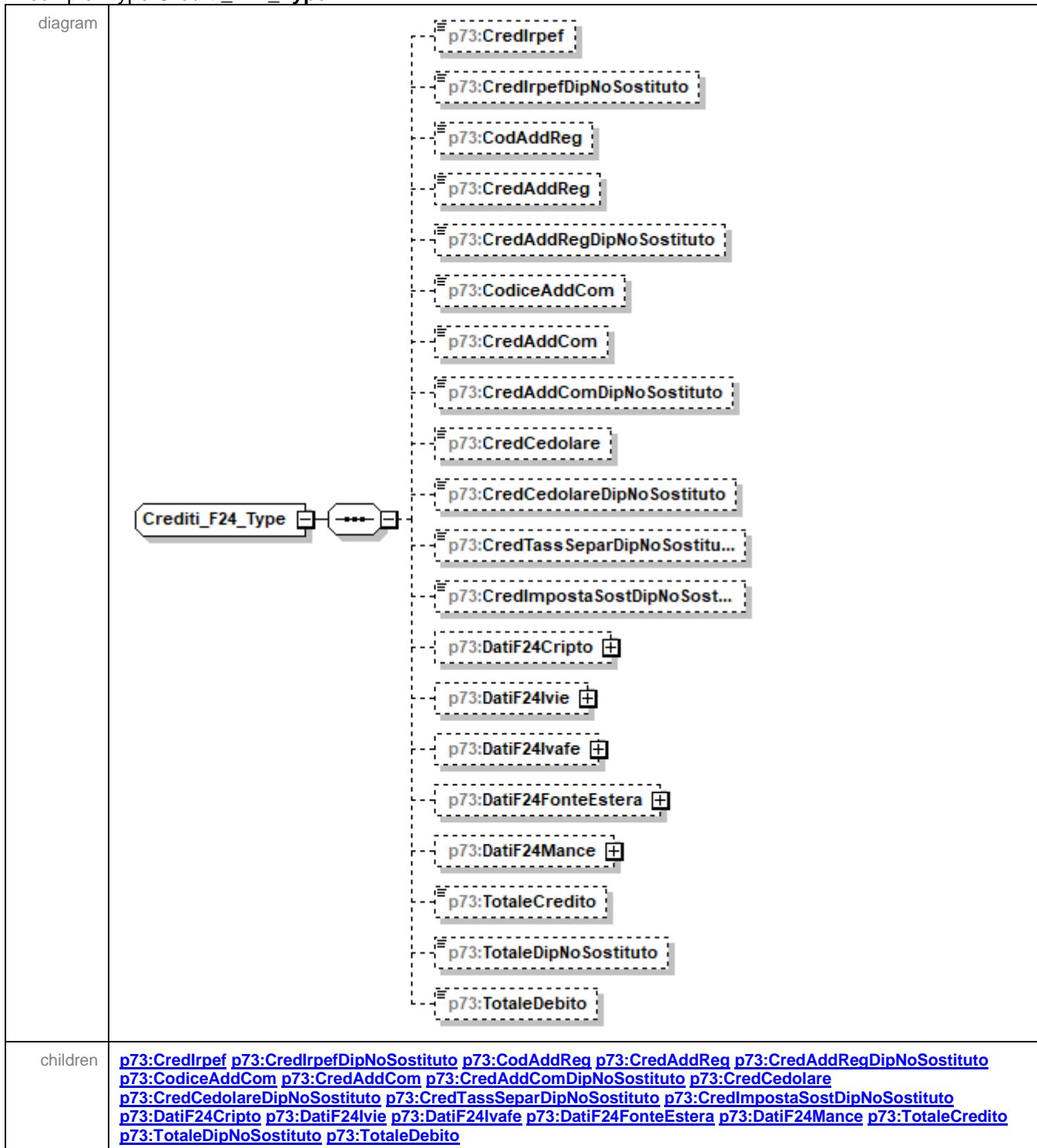

element **Crediti_F24_Type/Credlrpef**

diagram	
type	DatoNP_Type

element **Crediti_F24_Type/CredlrpefDipNoSostituto**

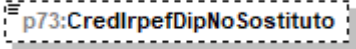
diagram	
type	DatoNP_Type

element **Crediti_F24_Type/CodAddReg**

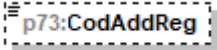
diagram																																													
type	Codice Regione Type																																												
facets	<table border="1"> <thead> <tr> <th>Kind</th> <th>Value</th> </tr> </thead> <tbody> <tr><td>enumeration</td><td>1</td></tr> <tr><td>enumeration</td><td>2</td></tr> <tr><td>enumeration</td><td>3</td></tr> <tr><td>enumeration</td><td>4</td></tr> <tr><td>enumeration</td><td>5</td></tr> <tr><td>enumeration</td><td>6</td></tr> <tr><td>enumeration</td><td>7</td></tr> <tr><td>enumeration</td><td>8</td></tr> <tr><td>enumeration</td><td>9</td></tr> <tr><td>enumeration</td><td>10</td></tr> <tr><td>enumeration</td><td>11</td></tr> <tr><td>enumeration</td><td>12</td></tr> <tr><td>enumeration</td><td>13</td></tr> <tr><td>enumeration</td><td>14</td></tr> <tr><td>enumeration</td><td>15</td></tr> <tr><td>enumeration</td><td>16</td></tr> <tr><td>enumeration</td><td>17</td></tr> <tr><td>enumeration</td><td>18</td></tr> <tr><td>enumeration</td><td>19</td></tr> <tr><td>enumeration</td><td>20</td></tr> <tr><td>enumeration</td><td>21</td></tr> </tbody> </table>	Kind	Value	enumeration	1	enumeration	2	enumeration	3	enumeration	4	enumeration	5	enumeration	6	enumeration	7	enumeration	8	enumeration	9	enumeration	10	enumeration	11	enumeration	12	enumeration	13	enumeration	14	enumeration	15	enumeration	16	enumeration	17	enumeration	18	enumeration	19	enumeration	20	enumeration	21
Kind	Value																																												
enumeration	1																																												
enumeration	2																																												
enumeration	3																																												
enumeration	4																																												
enumeration	5																																												
enumeration	6																																												
enumeration	7																																												
enumeration	8																																												
enumeration	9																																												
enumeration	10																																												
enumeration	11																																												
enumeration	12																																												
enumeration	13																																												
enumeration	14																																												
enumeration	15																																												
enumeration	16																																												
enumeration	17																																												
enumeration	18																																												
enumeration	19																																												
enumeration	20																																												
enumeration	21																																												

element **Crediti_F24_Type/CredAddReg**

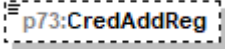
diagram	
type	DatoNP_Type

element **Crediti_F24_Type/CredAddRegDipNoSostituto**

diagram	
---------	---

type	DatoNP_Type
------	-----------------------------

element **Crediti_F24_Type/CodiceAddCom**

diagram	
type	DatoAN_Type

element **Crediti_F24_Type/CredAddCom**

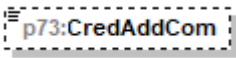
diagram	
type	DatoNP_Type

element **Crediti_F24_Type/CredAddComDipNoSostituto**

diagram	
type	DatoNP_Type

element **Crediti_F24_Type/CredCedolare**

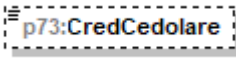
diagram	
type	DatoNP_Type

element **Crediti_F24_Type/CredCedolareDipNoSostituto**

diagram	
type	DatoNP_Type

element **Crediti_F24_Type/CredTassSeparDipNoSostituto**

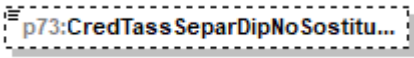
diagram	
type	DatoNP_Type

element **Crediti_F24_Type/CredImpostaSostDipNoSostituto**

diagram	
type	DatoNP_Type

element **Crediti_F24_Type/DatiF24Cripto**

diagram	
type	p73:Dati_F24_Type
children	p73:Credito p73:Debito p73:PrimaRataAcconto p73:SecondaRataAcconto

element **Crediti_F24_Type/DatiF24Ivie**

diagram	
type	p73:Dati_F24_Type
children	p73:Credito p73:Debito p73:PrimaRataAcconto p73:SecondaRataAcconto

element **Crediti_F24_Type/DatiF24Ivafe**

diagram	
type	p73:Dati_F24_Type
children	p73:Credito p73:Debito p73:PrimaRataAcconto p73:SecondaRataAcconto

element **Crediti_F24_Type/DatiF24FonteEstera**

diagram	
children	p73:Credito p73:Debito

element **Crediti_F24_Type/DatiF24FonteEstera/Credito**

diagram	
type	DatoNP_Type

element **Crediti_F24_Type/DatiF24FonteEstera/Debito**

diagram	
type	DatoNP_Type

element **Crediti_F24_Type/DatiF24Mance**

diagram	
children	p73:Credito p73:Debito

element **Crediti_F24_Type/DatiF24Mance/Credito**

diagram	
type	DatoNP_Type

element **Crediti_F24_Type/DatiF24Mance/Debito**

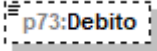
diagram	
type	DatoNP_Type

element **Crediti_F24_Type/TotaleCredito**

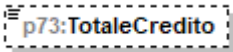
diagram	
type	DatoNP_Type

element **Crediti_F24_Type/TotaleDipNoSostituto**

diagram	
type	DatoNP_Type

element **Crediti_F24_Type/TotaleDebito**

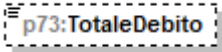
diagram	
type	DatoNP_Type

complexType **Crediti_Imposta_Altri_Sisma_Abruzzo_Type**

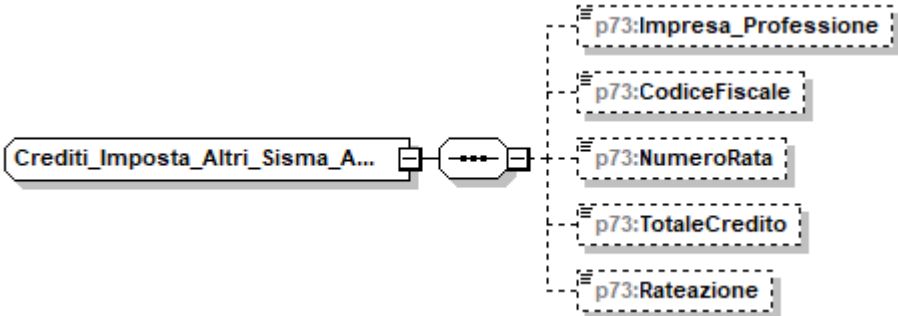
diagram	
---------	--

children	p73:Impresa_Professione p73:CodiceFiscale p73:NumeroRata p73:TotaleCredito p73:Rateazione
----------	---

element **Crediti_Imposta_Altri_Sisma_Abruzzo_Type/Impresa_Professione**

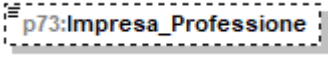
diagram	
type	DatoCB_Type

element **Crediti_Imposta_Altri_Sisma_Abruzzo_Type/CodiceFiscale**

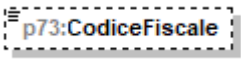
diagram	
type	DatoCF_Type

element **Crediti_Imposta_Altri_Sisma_Abruzzo_Type/NumeroRata**

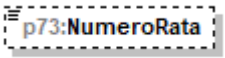
diagram																							
type	restriction of DatoNP_Type																						
facets	<table border="1"> <thead> <tr> <th>Kind</th> <th>Value</th> </tr> </thead> <tbody> <tr><td>enumeration</td><td>1</td></tr> <tr><td>enumeration</td><td>2</td></tr> <tr><td>enumeration</td><td>3</td></tr> <tr><td>enumeration</td><td>4</td></tr> <tr><td>enumeration</td><td>5</td></tr> <tr><td>enumeration</td><td>6</td></tr> <tr><td>enumeration</td><td>7</td></tr> <tr><td>enumeration</td><td>8</td></tr> <tr><td>enumeration</td><td>9</td></tr> <tr><td>enumeration</td><td>10</td></tr> </tbody> </table>	Kind	Value	enumeration	1	enumeration	2	enumeration	3	enumeration	4	enumeration	5	enumeration	6	enumeration	7	enumeration	8	enumeration	9	enumeration	10
Kind	Value																						
enumeration	1																						
enumeration	2																						
enumeration	3																						
enumeration	4																						
enumeration	5																						
enumeration	6																						
enumeration	7																						
enumeration	8																						
enumeration	9																						
enumeration	10																						

element **Crediti_Imposta_Altri_Sisma_Abruzzo_Type/TotaleCredito**

diagram	
type	DatoNP_Type

element **Crediti_Imposta_Altri_Sisma_Abruzzo_Type/Rateazione**

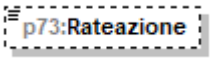
diagram							
type	restriction of DatoNP_Type						
facets	<table border="1"> <thead> <tr> <th>Kind</th> <th>Value</th> </tr> </thead> <tbody> <tr><td>enumeration</td><td>5</td></tr> <tr><td>enumeration</td><td>10</td></tr> </tbody> </table>	Kind	Value	enumeration	5	enumeration	10
Kind	Value						
enumeration	5						
enumeration	10						

complexType **Crediti_Imposta_Fabbricati_Type**

diagram	
children	p73:ResiduoFabbricati p73:CanoniLocazioneNonPercepiti

element **Crediti_Imposta_Fabbricati_Type/ResiduoFabbricati**

diagram	
type	p73:Residuo_Fabbricati_Type
children	p73:ResiduoPrecedenteDichiarazione p73:CreditoAnno p73:DiCuiCompensatoF24

element **Crediti_Imposta_Fabbricati_Type/CanoniLocazioneNonPercepiti**

diagram	
type	DatoNP_Type

complexType **Crediti_Imposta_Fondi_Pensione_Type**

diagram	
children	p73:AnnoAnticipazione p73:Reintegro p73:SommaReintegrata p73:CreditoAnno

element **Crediti_Imposta_Fondi_Pensione_Type/AnnoAnticipazione**

diagram	
---------	--

type	p73:Anno_Anticipazione_Fondo_Pensione_Type	
facets	Kind	Value
	enumeration	2007
	enumeration	2008
	enumeration	2009
	enumeration	2010
	enumeration	2011
	enumeration	2012
	enumeration	2013
	enumeration	2014
	enumeration	2015
	enumeration	2016
	enumeration	2017
	enumeration	2018
	enumeration	2019
	enumeration	2020
	enumeration	2021
	enumeration	2022

element **Crediti_Imposta_Fondi_Pensione_Type/Reintegro**

diagram		
type	p73:Reintegro_Totale_Parziale_Type	
facets	Kind	Value
	enumeration	1
	enumeration	2

element **Crediti_Imposta_Fondi_Pensione_Type/SommaReintegrata**

diagram		
type	DatoNP_Type	

element **Crediti_Imposta_Fondi_Pensione_Type/CreditoAnno**

diagram		
type	DatoNP_Type	

complexType **Crediti_Imposta_Redditi_Esteri_Type**

<p>diagram</p>	
<p>children</p>	<p>p73:StatoEstero p73:Anno p73:RedditoEstero p73:ImpostaEstera p73:RedditoComplessivo p73:Imposta_Lorda p73:ImpostaNetta p73:CreditoDichiarazioniPrecedenti p73:DiCuiStatoEstero</p>

element **Crediti_Imposta_Redditi_Esteri_Type/StatoEstero**

<p>diagram</p>	
<p>type</p>	<p>DatoAN_Type</p>

element **Crediti_Imposta_Redditi_Esteri_Type/Anno**

<p>diagram</p>	
<p>type</p>	<p>restriction of DatoDA_Type</p>

element **Crediti_Imposta_Redditi_Esteri_Type/RedditoEstero**

<p>diagram</p>	
<p>type</p>	<p>DatoNP_Type</p>

element **Crediti_Imposta_Redditi_Esteri_Type/ImpostaEstera**

<p>diagram</p>	
----------------	--

type	DatoNP_Type
------	-----------------------------

element **Crediti_Imposta_Redditi_Esteri_Type/RedditoComlessivo**

diagram	
type	DatoNP_Type

element **Crediti_Imposta_Redditi_Esteri_Type/Imposta_Lorda**

diagram	
type	DatoNP_Type

element **Crediti_Imposta_Redditi_Esteri_Type/ImpostaNetta**

diagram	
type	DatoNP_Type

element **Crediti_Imposta_Redditi_Esteri_Type/CreditoDichiarazioniPrecedenti**

diagram	
type	DatoNP_Type

element **Crediti_Imposta_Redditi_Esteri_Type/DiCuiStatoEstero**

diagram	
type	DatoNP_Type

complexType **Crediti_Imposta_Type**

diagram	
children	p73:PrimoModulo p73:Modulo

element **Crediti_Imposta_Type/PrimoModulo**

<p>diagram</p>	
<p>type</p>	<p>p73:Primo Modulo Crediti Imposta Type</p>
<p>children</p>	<p>p73:CreditoImpostaFabbricati p73:CreditoImpostaFondiPensione p73:CreditoImpostaRedditiEsteri p73:CreditoPrimaCasaSismaAbruzzo p73:CreditoAltriSismaAbruzzo p73:CreditoPrimaCasaU36 p73:CreditoErogazioniCultura p73:AltriCreditoImposta</p>

element **Crediti_Imposta_Type/Modulo**

<p>diagram</p>	
<p>type</p>	<p>p73:Modulo Crediti Imposta Type</p>
<p>children</p>	<p>p73:CreditoImpostaFondiPensione p73:CreditoImpostaRedditiEsteri p73:CreditoPrimaCasaSismaAbruzzo p73:CreditoAltriSismaAbruzzo p73:CreditoNegoziazione p73:AltriCreditoImposta</p>

complexType Credito_Ape

diagram	
children	p73:Utilizzato

element Credito_Ape/Utilizzato

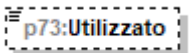
diagram	
type	DatoNP_Type

complexType Credito_Erogazioni_Cultura_Type

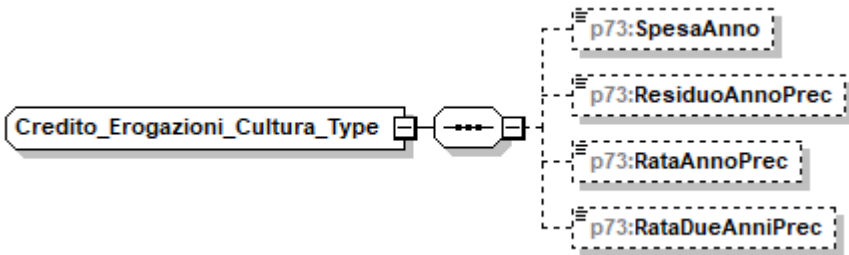
diagram	
children	p73:SpesaAnno p73:ResiduoAnnoPrec p73:RataAnnoPrec p73:RataDueAnniPrec

element Credito_Erogazioni_Cultura_Type/SpesaAnno

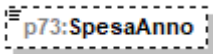
diagram	
type	DatoNP_Type

element Credito_Erogazioni_Cultura_Type/ResiduoAnnoPrec

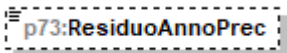
diagram	
type	DatoNP_Type

element Credito_Erogazioni_Cultura_Type/RataAnnoPrec

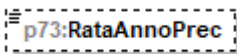
diagram	
type	DatoNP_Type

element **Credito_Erogazioni_Cultura_Type/RataDueAnniPrec**

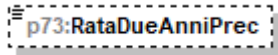
diagram	
type	DatoNP_Type

complexType **Credito_Erogazioni_Scuola_Type**

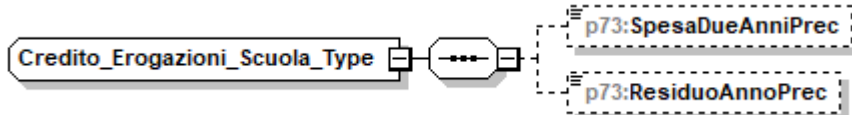
diagram	
children	p73:SpesaDueAnniPrec p73:ResiduoAnnoPrec

element **Credito_Erogazioni_Scuola_Type/SpesaDueAnniPrec**

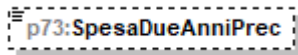
diagram	
type	DatoNP_Type

element **Credito_Erogazioni_Scuola_Type/ResiduoAnnoPrec**

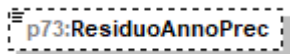
diagram	
type	DatoNP_Type

complexType **Credito_Immibile_Sisma_Abruzzo_Type**

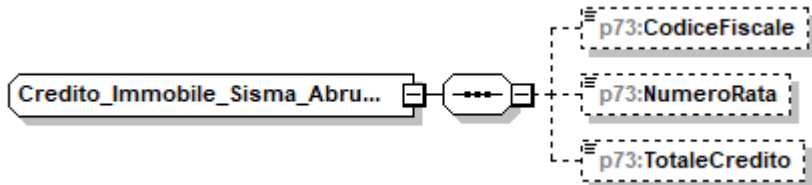
diagram	
children	p73:CodiceFiscale p73:NumeroRata p73:TotaleCredito

element **Credito_Immibile_Sisma_Abruzzo_Type/CodiceFiscale**

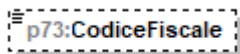
diagram	
type	DatoCF_Type

element **Credito_Immobile_Sisma_Abruzzo_Type/NumeroRata**

diagram																																	
type	restriction of DatoNP_Type																																
facets	<table border="1"> <thead> <tr> <th>Kind</th> <th>Value</th> </tr> </thead> <tbody> <tr><td>enumeration</td><td>1</td></tr> <tr><td>enumeration</td><td>2</td></tr> <tr><td>enumeration</td><td>3</td></tr> <tr><td>enumeration</td><td>4</td></tr> <tr><td>enumeration</td><td>5</td></tr> <tr><td>enumeration</td><td>6</td></tr> <tr><td>enumeration</td><td>7</td></tr> <tr><td>enumeration</td><td>8</td></tr> <tr><td>enumeration</td><td>9</td></tr> <tr><td>enumeration</td><td>10</td></tr> <tr><td>enumeration</td><td>11</td></tr> <tr><td>enumeration</td><td>12</td></tr> <tr><td>enumeration</td><td>13</td></tr> <tr><td>enumeration</td><td>14</td></tr> <tr><td>enumeration</td><td>15</td></tr> </tbody> </table>	Kind	Value	enumeration	1	enumeration	2	enumeration	3	enumeration	4	enumeration	5	enumeration	6	enumeration	7	enumeration	8	enumeration	9	enumeration	10	enumeration	11	enumeration	12	enumeration	13	enumeration	14	enumeration	15
Kind	Value																																
enumeration	1																																
enumeration	2																																
enumeration	3																																
enumeration	4																																
enumeration	5																																
enumeration	6																																
enumeration	7																																
enumeration	8																																
enumeration	9																																
enumeration	10																																
enumeration	11																																
enumeration	12																																
enumeration	13																																
enumeration	14																																
enumeration	15																																

element **Credito_Immobile_Sisma_Abruzzo_Type/TotaleCredito**

diagram	
type	DatoNP_Type

complexType **Credito_Negoziatore_Type**

diagram	
children	p73:CreditoSpettante p73:ResiduoAnnoPrec p73:DiCuiCompensatoF24

element **Credito_Negoziatore_Type/CreditoSpettante**

diagram	
type	DatoNP_Type

element **Credito_Negoziatore_Type/ResiduoAnnoPrec**

diagram	
type	DatoNP_Type

element **Credito_Negoziazione_Type/DiCuiCompensatoF24**

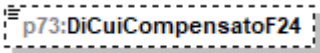
diagram	
type	DatoNP_Type

complexType **Credito_Prima_Casa_U36**

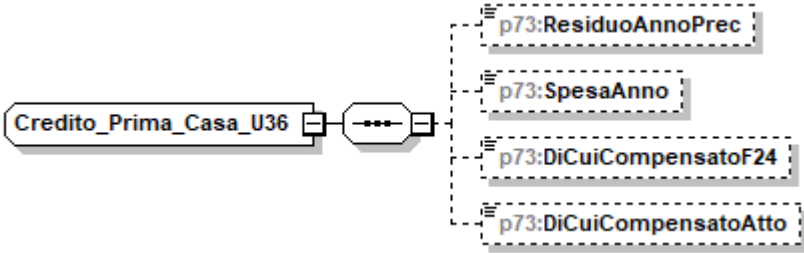
diagram	
children	p73:ResiduoAnnoPrec p73:SpesaAnno p73:DiCuiCompensatoF24 p73:DiCuiCompensatoAtto

element **Credito_Prima_Casa_U36/ResiduoAnnoPrec**

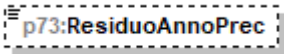
diagram	
type	DatoNP_Type

element **Credito_Prima_Casa_U36/SpesaAnno**

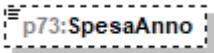
diagram	
type	DatoNP_Type

element **Credito_Prima_Casa_U36/DiCuiCompensatoF24**

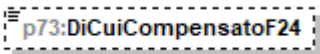
diagram	
type	DatoNP_Type

element **Credito_Prima_Casa_U36/DiCuiCompensatoAtto**

diagram	
type	DatoNP_Type

complexType Credito_Stato_Type

diagram	
children	p73:Stato p73:Credito

element Credito_Stato_Type/Stato

diagram	
type	DatoAN_Type

element Credito_Stato_Type/Credito

diagram	
type	DatoNP_Type

complexType Credito_Type

diagram	
children	p73:NonRimborsabile p73:Credito p73:CreditoF24 p73:CreditoRimborso

element Credito_Type/NonRimborsabile

diagram	
type	DatoNP_Type

element **Credito_Type/Credito**

diagram	
type	DatoNP_Type

element **Credito_Type/CreditoF24**

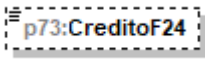
diagram	
type	DatoNP_Type

element **Credito_Type/CreditoRimborso**

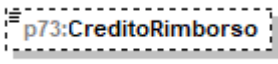
diagram	
type	DatoNP_Type

complexType **Credito_Videosorveglianza_Type**

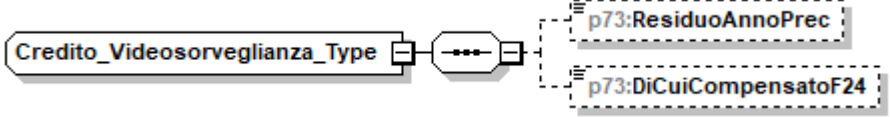
diagram	
children	p73:ResiduoAnnoPrec p73:DiCuiCompensatoF24

element **Credito_Videosorveglianza_Type/ResiduoAnnoPrec**

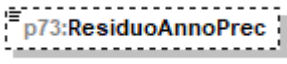
diagram	
type	DatoNP_Type

element **Credito_Videosorveglianza_Type/DiCuiCompensatoF24**

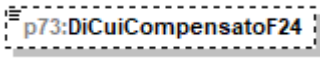
diagram	
type	DatoNP_Type

complexType **Dati_730_Integrativo_Type**

diagram	
children	p73:Rimborso p73:Credito

element **Dati_730_Integrativo_Type/Rimborso**

diagram	
type	p73:Elemento_Integrativo_Type
children	p73:lrpef p73:AddizionaleRegionalelrpef p73:AddComunalelrpef p73:CedolareSecca

element **Dati_730_Integrativo_Type/Credito**

diagram	
type	p73:Elemento_Integrativo_Type
children	p73:lrpef p73:AddizionaleRegionalelrpef p73:AddComunalelrpef p73:CedolareSecca

complexType **Dati_Altre_Detrazioni_Modulo_Type**

diagram	
children	p73:AltreDetrazioni

element **Dati_Altre_Detrazioni_Modulo_Type/AltreDetrazioni**

diagram	
type	p73:Altre_Detrazioni_Type
children	p73:Codice p73:Importo

complexType **Dati_Altre_Detrazioni_Type**

diagram	
children	p73:SpeseCaniGuida p73:AltreDetrazioni

element **Dati_Altre_Detrazioni_Type/SpeseCaniGuida**

diagram	
type	DatoCB_Type

element **Dati_Altre_Detrazioni_Type/AltreDetrazioni**

diagram	
type	p73:Altre_Detrazioni_Type
children	p73:Codice p73:Importo

complexType **Dati_Catastali_Recupero_Patrimonio_Edilizio_Type**

diagram	
children	p73:NOrdImmobile p73:Condominio p73:DatiCatastali

element **Dati_Catastali_Recupero_Patrimonio_Edilizio_Type/NOrdImmobile**

diagram	
type	DatoNP_Type

element **Dati_Catastali_Recupero_Patrimonio_Edilizio_Type/Condominio**

diagram	
type	DatoCB_Type

element **Dati_Catastali_Recupero_Patrimonio_Edilizio_Type/DatiCatastali**

diagram	
type	p73:Dati_Catastali_Type
children	p73:CodiceComune p73:TerreniUrbano p73:SezioneUrbanaComuneCatastale p73:Foglio p73:Particella p73:Subalterno

complexType **Dati_Catastali_Type**

<p>diagram</p>	
<p>children</p>	<p>p73:CodiceComune p73:TerreniUrbano p73:SezioneUrbanaComuneCatastale p73:Foglio p73:Particella p73:Subalterno</p>

element **Dati_Catastali_Type/CodiceComune**

<p>diagram</p>	
<p>type</p>	<p>DatoAN_Type</p>

element **Dati_Catastali_Type/TerreniUrbano**

<p>diagram</p>							
<p>type</p>	<p>p73:Terreni_Urbano_Type</p>						
<p>facets</p>	<table border="1"> <thead> <tr> <th>Kind</th> <th>Value</th> </tr> </thead> <tbody> <tr> <td>enumeration</td> <td>T</td> </tr> <tr> <td>enumeration</td> <td>U</td> </tr> </tbody> </table>	Kind	Value	enumeration	T	enumeration	U
Kind	Value						
enumeration	T						
enumeration	U						

element **Dati_Catastali_Type/SezioneUrbanaComuneCatastale**

<p>diagram</p>	
<p>type</p>	<p>DatoAN_Type</p>

element **Dati_Catastali_Type/Foglio**

<p>diagram</p>	
<p>type</p>	<p>DatoAN_Type</p>

element **Dati_Catastali_Type/Particella**

diagram	
children	p73:Numeratore p73:Denominatore

element **Dati_Catastali_Type/Particella/Numeratore**

diagram	
type	DatoAN_Type

element **Dati_Catastali_Type/Particella/Denominatore**

diagram	
type	DatoAN_Type

element **Dati_Catastali_Type/Subalterno**

diagram	
type	DatoAN_Type

complexType **Dati_Coniuge_Type**

diagram	
children	p73:Tipo p73:CodiceFiscale p73:Mesi

element **Dati_Coniuge_Type/Tipo**

diagram	
type	DatoCB_Type

element **Dati_Coniuge_Type/CodiceFiscale**

diagram	
type	DatoCF_Type

element **Dati_Coniuge_Type/Mesi**

diagram																											
type	p73:Mesi_Type																										
facets	<table border="1"> <thead> <tr> <th>Kind</th> <th>Value</th> </tr> </thead> <tbody> <tr><td>enumeration</td><td>1</td></tr> <tr><td>enumeration</td><td>2</td></tr> <tr><td>enumeration</td><td>3</td></tr> <tr><td>enumeration</td><td>4</td></tr> <tr><td>enumeration</td><td>5</td></tr> <tr><td>enumeration</td><td>6</td></tr> <tr><td>enumeration</td><td>7</td></tr> <tr><td>enumeration</td><td>8</td></tr> <tr><td>enumeration</td><td>9</td></tr> <tr><td>enumeration</td><td>10</td></tr> <tr><td>enumeration</td><td>11</td></tr> <tr><td>enumeration</td><td>12</td></tr> </tbody> </table>	Kind	Value	enumeration	1	enumeration	2	enumeration	3	enumeration	4	enumeration	5	enumeration	6	enumeration	7	enumeration	8	enumeration	9	enumeration	10	enumeration	11	enumeration	12
Kind	Value																										
enumeration	1																										
enumeration	2																										
enumeration	3																										
enumeration	4																										
enumeration	5																										
enumeration	6																										
enumeration	7																										
enumeration	8																										
enumeration	9																										
enumeration	10																										
enumeration	11																										
enumeration	12																										

complexType **Dati_Contabili_Type**

diagram	
children	p73:Familiari p73:QuadroA p73:QuadroB p73:QuadroC p73:QuadroD p73:QuadroE p73:QuadroF p73:QuadroG p73:ProspettoLiquidazione p73:QuadroL p73:QuadroW

element **Dati Contabili Type/Familiari**

diagram	
type	p73:Familiari_Type
children	p73:PrimoModulo p73:Modulo

element **Dati Contabili Type/QuadroA**

diagram	
type	p73:Redditi_Terreni_Type
children	p73:Modulo

element **Dati Contabili Type/QuadroB**

diagram	
type	p73:Redditi_Fabbricati_Type
children	p73:Modulo

element **Dati_Contabili_Type/QuadroC**

diagram	
type	p73:Redditi_Lavoro_Dip_Type
children	p73:PrimoModulo p73:Modulo

element **Dati_Contabili_Type/QuadroD**

diagram	
type	extension of p73:Altri_Redditi_Type
children	p73:Modulo

element **Dati_Contabili_Type/QuadroE**

diagram	
type	p73:Oneri_Type
children	p73:PrimoModulo p73:Modulo

element **Dati_Contabili_Type/QuadroF**

<p>diagram</p>	
<p>type</p>	<p>p73:Acconti_Ritenute_Type</p>
<p>children</p>	<p>p73:PrimoModulo p73:Modulo</p>

element **Dati_Contabili_Type/QuadroG**

<p>diagram</p>	
<p>type</p>	<p>p73:Crediti_Imposta_Type</p>
<p>children</p>	<p>p73:PrimoModulo p73:Modulo</p>

element **Dati_Contabili_Type/ProspettoLiquidazione**

<p>diagram</p>	
<p>type</p>	<p>p73:Prospetto_Liquidazione_Type</p>
<p>children</p>	<p>p73:PrimoModulo p73:Modulo</p>

element **Dati_Contabili_Type/QuadroL**

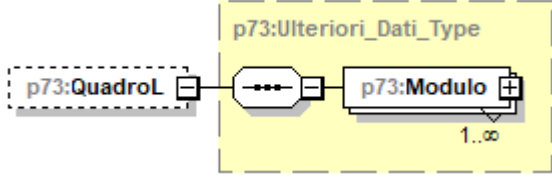
diagram	
type	p73:Ulteriori_Dati_Type
children	p73:Modulo

element **Dati_Contabili_Type/QuadroW**

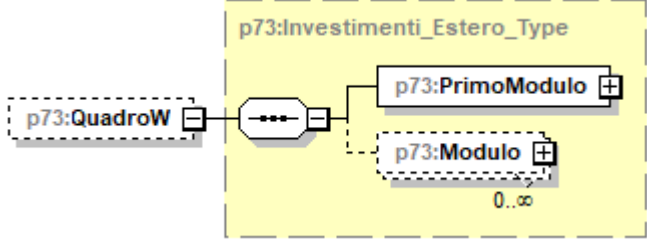
diagram	
type	p73:Investimenti_Estero_Type
children	p73:PrimoModulo p73:Modulo

complexType **Dati_Contratto_Type**

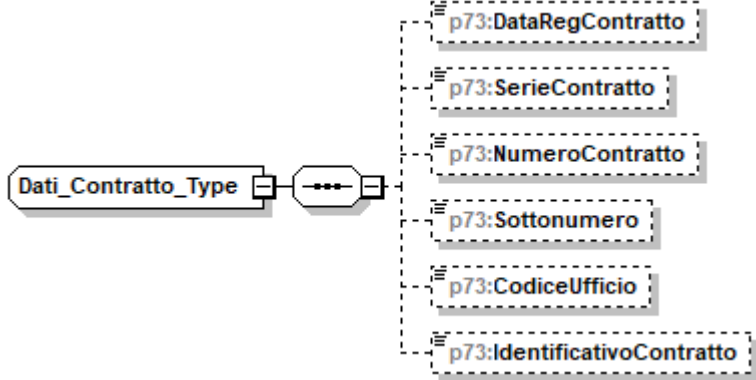
diagram	
children	p73:DataRegContratto p73:SerieContratto p73:NumeroContratto p73:Sottonumero p73:CodiceUfficio p73:IdentificativoContratto

element **Dati_Contratto_Type/DataRegContratto**

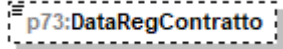
diagram	
type	DatoDT_Type

element **Dati_Contratto_Type/SerieContratto**

diagram															
type	p73:Serie_Registrazione_Contratto_Type														
facets	<table border="1"> <thead> <tr> <th>Kind</th> <th>Value</th> </tr> </thead> <tbody> <tr> <td>enumeration</td> <td>3</td> </tr> <tr> <td>enumeration</td> <td>3A</td> </tr> <tr> <td>enumeration</td> <td>3B</td> </tr> <tr> <td>enumeration</td> <td>3P</td> </tr> <tr> <td>enumeration</td> <td>1T</td> </tr> <tr> <td>enumeration</td> <td>3T</td> </tr> </tbody> </table>	Kind	Value	enumeration	3	enumeration	3A	enumeration	3B	enumeration	3P	enumeration	1T	enumeration	3T
Kind	Value														
enumeration	3														
enumeration	3A														
enumeration	3B														
enumeration	3P														
enumeration	1T														
enumeration	3T														

element **Dati_Contratto_Type/NumeroContratto**

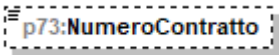
diagram	
type	DatoAN_Type

element **Dati_Contratto_Type/Sottonumero**

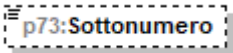
diagram	
type	DatoAN_Type

element **Dati_Contratto_Type/CodiceUfficio**

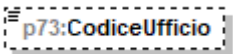
diagram	
type	restriction of DatoAN_Type

element **Dati_Contratto_Type/IdentificativoContratto**

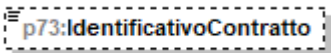
diagram	
type	DatoAN_Type

complexType **Dati_F24_Type**

diagram	
children	p73:Credito p73:Debito p73:PrimaRataAcconto p73:SecondaRataAcconto

element **Dati_F24_Type/Credito**

diagram	
type	DatoNP_Type

element **Dati_F24_Type/Debito**

diagram	
type	DatoNP_Type

element **Dati_F24_Type/PrimaRataAcconto**

diagram	
type	DatoNP_Type

element **Dati_F24_Type/SecondaRataAcconto**

diagram	
type	DatoNP_Type

complexType **Dati_Familiare_Type**

<p>diagram</p>	
<p>children</p>	<p>p73:CodiceFiscale p73:Mesi p73:PercDetraz p73:PercDetrazCon p73:Affidamento p73:MesiDetraz21Anni</p>

element **Dati_Familiare_Type/CodiceFiscale**

<p>diagram</p>	
<p>type</p>	<p>DatoCF_Type</p>

element **Dati_Familiare_Type/Mesi**

<p>diagram</p>	
<p>type</p>	<p>DatoNP_Type</p>

element **Dati_Familiare_Type/PercDetraz**

<p>diagram</p>	
<p>type</p>	<p>DatoPC_Type</p>

element **Dati_Familiare_Type/PercDetrazCon**

<p>diagram</p>	
<p>type</p>	<p>DatoAN_Type</p>

element **Dati_Familiare_Type/Affidamento**

<p>diagram</p>	
----------------	--

type	DatoCB_Type
------	-----------------------------

element **Dati_Familiare_Type/MesiDetraz21Anni**

diagram	
type	DatoNP_Type

complexType **Dati_Nascita_PF_Type**

diagram	
children	p73:Sesso p73:DataNascita p73:ComuneNascita p73:ProvinciaNascita

element **Dati_Nascita_PF_Type/Sesso**

diagram							
type	Sesso_Type						
facets	<table border="1"> <thead> <tr> <th>Kind</th> <th>Value</th> </tr> </thead> <tbody> <tr> <td>enumeration</td> <td>M</td> </tr> <tr> <td>enumeration</td> <td>F</td> </tr> </tbody> </table>	Kind	Value	enumeration	M	enumeration	F
Kind	Value						
enumeration	M						
enumeration	F						

element **Dati_Nascita_PF_Type/DataNascita**

diagram	
type	DatoDT_Type

element **Dati_Nascita_PF_Type/ComuneNascita**

diagram	
type	DatoAN_Type

element **Dati_Nascita_PF_Type/ProvinciaNascita**

diagram	
type	PN_Type

complexType **Dati_Primo_Figlio_Type**

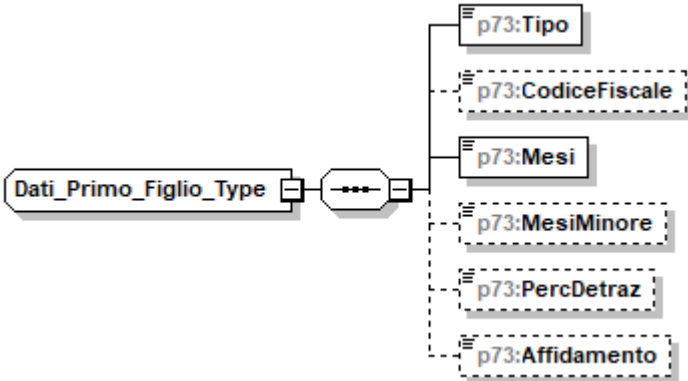
diagram	
children	p73:Tipo p73:CodiceFiscale p73:Mesi p73:MesiMinore p73:PercDetraz p73:Affidamento

element **Dati_Primo_Figlio_Type/Tipo**

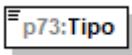
diagram							
type	restriction of DatoAN_Type						
facets	<table border="1"> <thead> <tr> <th>Kind</th> <th>Value</th> </tr> </thead> <tbody> <tr> <td>enumeration</td> <td>F</td> </tr> <tr> <td>enumeration</td> <td>D</td> </tr> </tbody> </table>	Kind	Value	enumeration	F	enumeration	D
Kind	Value						
enumeration	F						
enumeration	D						

element **Dati_Primo_Figlio_Type/CodiceFiscale**

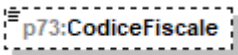
diagram	
type	DatoCF_Type

element **Dati_Primo_Figlio_Type/Mesi**

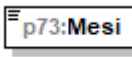
diagram											
type	p73:Mesi_Type										
facets	<table border="1"> <thead> <tr> <th>Kind</th> <th>Value</th> </tr> </thead> <tbody> <tr> <td>enumeration</td> <td>1</td> </tr> <tr> <td>enumeration</td> <td>2</td> </tr> <tr> <td>enumeration</td> <td>3</td> </tr> <tr> <td>enumeration</td> <td>4</td> </tr> </tbody> </table>	Kind	Value	enumeration	1	enumeration	2	enumeration	3	enumeration	4
Kind	Value										
enumeration	1										
enumeration	2										
enumeration	3										
enumeration	4										

enumeration	5
enumeration	6
enumeration	7
enumeration	8
enumeration	9
enumeration	10
enumeration	11
enumeration	12

element **Dati_Primo_Figlio_Type/MesiMinore**

diagram																											
type	p73:Mesi_Type																										
facets	<table border="1"> <thead> <tr> <th>Kind</th> <th>Value</th> </tr> </thead> <tbody> <tr><td>enumeration</td><td>1</td></tr> <tr><td>enumeration</td><td>2</td></tr> <tr><td>enumeration</td><td>3</td></tr> <tr><td>enumeration</td><td>4</td></tr> <tr><td>enumeration</td><td>5</td></tr> <tr><td>enumeration</td><td>6</td></tr> <tr><td>enumeration</td><td>7</td></tr> <tr><td>enumeration</td><td>8</td></tr> <tr><td>enumeration</td><td>9</td></tr> <tr><td>enumeration</td><td>10</td></tr> <tr><td>enumeration</td><td>11</td></tr> <tr><td>enumeration</td><td>12</td></tr> </tbody> </table>	Kind	Value	enumeration	1	enumeration	2	enumeration	3	enumeration	4	enumeration	5	enumeration	6	enumeration	7	enumeration	8	enumeration	9	enumeration	10	enumeration	11	enumeration	12
Kind	Value																										
enumeration	1																										
enumeration	2																										
enumeration	3																										
enumeration	4																										
enumeration	5																										
enumeration	6																										
enumeration	7																										
enumeration	8																										
enumeration	9																										
enumeration	10																										
enumeration	11																										
enumeration	12																										

element **Dati_Primo_Figlio_Type/PercDetraz**

diagram	
type	DatoPC_Type

element **Dati_Primo_Figlio_Type/Affidamento**

diagram	
type	DatoCB_Type

complexType **Dati_Registrazione_Accatamento_Recupero_Patrimonio_Edilizio_Type**

diagram	
---------	--

children	p73:NOrdImmobile p73:Condominio p73:EstremiRegistrazioneContratto p73:DomandaAccatamento
----------	--

element **Dati_Registrazione_Accatamento_Recupero_Patrimonio_Edilizio_Type/NOrdImmobile**

diagram	
type	DatoNP_Type

element **Dati_Registrazione_Accatamento_Recupero_Patrimonio_Edilizio_Type/Condominio**

diagram	
type	DatoCB_Type

element **Dati_Registrazione_Accatamento_Recupero_Patrimonio_Edilizio_Type/EstremiRegistrazioneContratto**

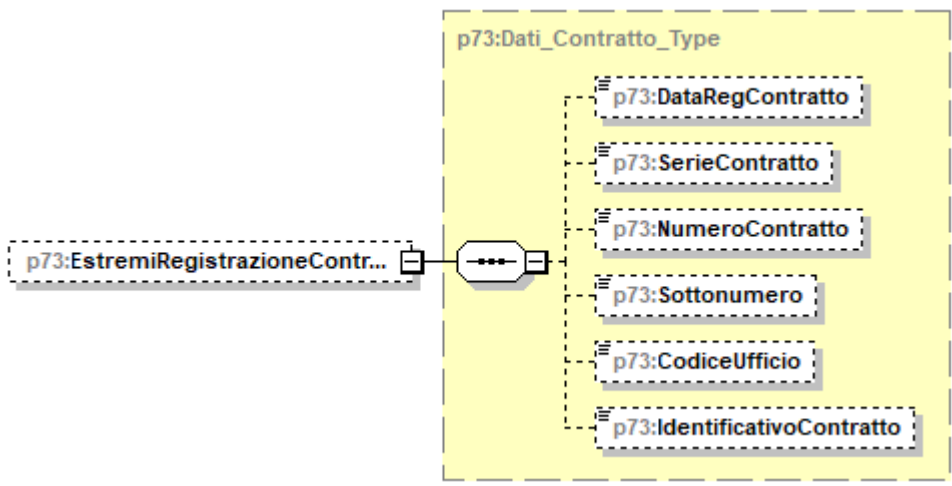
diagram	
type	p73:Dati_Contratto_Type
children	p73:DataRegContratto p73:SerieContratto p73:NumeroContratto p73:Sottonumero p73:CodiceUfficio p73:IdentificativoContratto

element

Dati_Registrazione_Accatastamento_Recupero_Patrimonio_Edilizio_Type/DomandaAccatastamento

diagram	
type	p73:Domanda_Accatastamento_Type
children	p73:Data p73:Numero p73:ProvinciaUfficio

complexType Debito_Type

diagram	
children	p73:NonVersare p73:ImportoDaTrattenere

element Debito_Type/NonVersare

diagram	
type	DatoNP_Type

element Debito_Type/ImportoDaTrattenere

diagram	
type	DatoNP_Type

complexType Deduzioni_Modulo_Type

diagram	
children	p73:AssegnoConiuge p73:AltriOneri p73:AcquistoCostruzioneAbitLocazione

element **Deduzioni_Modulo_Type/AssegnoConiuge**

diagram	
type	p73:Assegno Coniuge Type
children	p73:CodiceFiscale p73:Importo

element **Deduzioni_Modulo_Type/AltriOneri**

diagram	
type	p73:Altri Oneri Type
children	p73:Codice p73:Importo

element **Deduzioni_Modulo_Type/AcquistoCostruzioneAbitLocazione**

diagram	
type	p73:Acquisto Costruzione Abit Locazione
children	p73:DataStipula p73:Spesa p73:InteressiMutuo

complexType **Deduzioni_Type**

<p>diagram</p>	
<p>children</p>	<p>p73:ContributiPrevAss p73:AssegnoConiuge p73:ContributiColf p73:ErogazioniIstituzioniReligiose p73:SpesePortatoriHandicap p73:AltriOneri p73:DeducibilitaOrdinaria p73:LavoratoriPrimaOccupazione p73:FondiInSquilibrioFinanziario p73:FamiliariACarico p73:AcquistoCostruzioneAbitL... p73:RestituzioneSomme p73:ErogazioniOnlus</p>

element **Deduzioni_Type/ContributiPrevAss**

<p>diagram</p>	
<p>type</p>	<p>DatoNP_Type</p>

element **Deduzioni_Type/AssegnoConiuge**

<p>diagram</p>	
----------------	--

type	p73:Assegno_Coniuge_Type
children	p73:CodiceFiscale p73:Importo

element **Deduzioni_Type/ContributiColf**

diagram	
type	DatoNP_Type

element **Deduzioni_Type/ErogazioniIstituzioniReligiose**

diagram	
type	DatoNP_Type

element **Deduzioni_Type/SpesePortatoriHandicap**

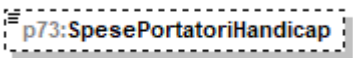
diagram	
type	DatoNP_Type

element **Deduzioni_Type/AltriOneri**

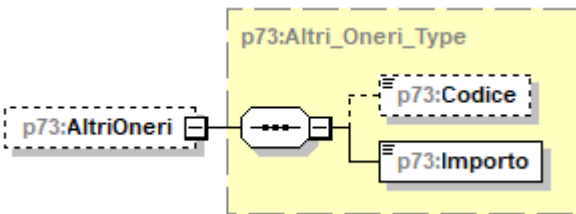
diagram	
type	p73:Altri_Oneri_Type
children	p73:Codice p73:Importo

element **Deduzioni_Type/DeducibilitaOrdinaria**

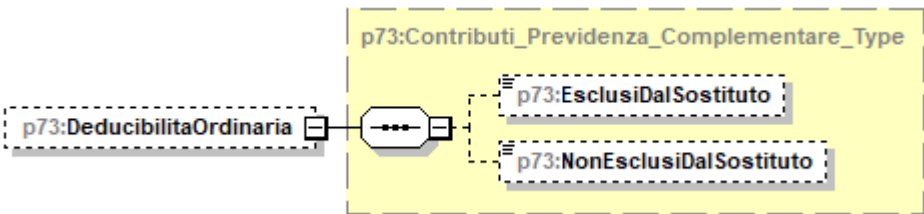
diagram	
type	p73:Contributi_Previdenza_Complementare_Type

children	p73:EsclusiDalSostituto p73:NonEsclusiDalSostituto
----------	--

element **Deduzioni_Type/LavoratoriPrimaOccupazione**

diagram	<p>The diagram shows a class <code>p73:LavoratoriPrimaOccupazione</code> (dashed box) connected to a class <code>p73:Contributi_Previdenza_Complementare_Type</code> (yellow box). The parent class has two children: <code>p73:EsclusiDalSostituto</code> and <code>p73:NonEsclusiDalSostituto</code> (both dashed boxes).</p>
type	p73:Contributi_Previdenza_Complementare_Type
children	p73:EsclusiDalSostituto p73:NonEsclusiDalSostituto

element **Deduzioni_Type/FondiInSquilibrioFinanziario**

diagram	<p>The diagram shows a class <code>p73:FondiInSquilibrioFinanziario</code> (dashed box) connected to a class <code>p73:Contributi_Previdenza_Complementare_Type</code> (yellow box). The parent class has two children: <code>p73:EsclusiDalSostituto</code> and <code>p73:NonEsclusiDalSostituto</code> (both dashed boxes).</p>
type	p73:Contributi_Previdenza_Complementare_Type
children	p73:EsclusiDalSostituto p73:NonEsclusiDalSostituto

element **Deduzioni_Type/FamiliariACarico**

diagram	<p>The diagram shows a class <code>p73:FamiliariACarico</code> (dashed box) connected to a class <code>p73:Contributi_Previdenza_Complementare_Type</code> (yellow box). The parent class has two children: <code>p73:EsclusiDalSostituto</code> and <code>p73:NonEsclusiDalSostituto</code> (both dashed boxes).</p>
type	p73:Contributi_Previdenza_Complementare_Type
children	p73:EsclusiDalSostituto p73:NonEsclusiDalSostituto

element **Deduzioni_Type/AcquistoCostruzioneAbitLocazione**

diagram	
type	p73:Acquisto_Costruzione_Abit_Locazione
children	p73:DataStipula p73:Spesa p73:InteressiMutuo

element **Deduzioni_Type/RestituzioneSomme**

diagram	
type	p73:Restituzione_Somme_Type
children	p73:SommeRestituite p73:ResiduoPrecedenteDic

element **Deduzioni_Type/ErogazioniOnlus**

diagram	
type	p73:Erogazioni_Onlus_Type
children	p73:Importo p73:ResiduoPrecedenteDic p73:ResiduoDueAnniPrecDic p73:ResiduoTreAnniPrecDic p73:ResiduoQuattroAnniPrecDic

complexType **Detrazione_Crediti_Type**

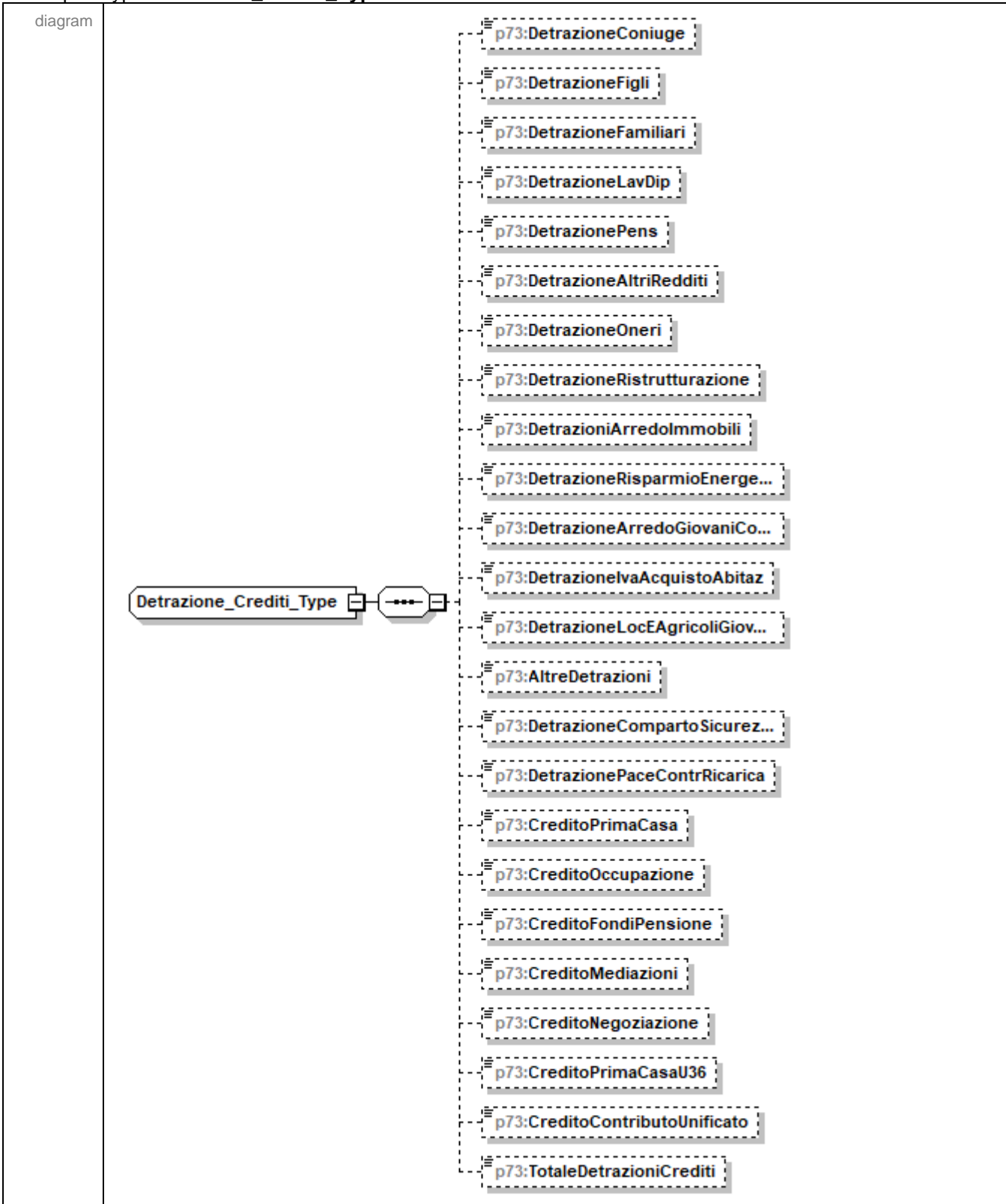

children	p73:DetrazioneConiuge p73:DetrazioneFigli p73:DetrazioneFamiliari p73:DetrazioneLavDip p73:DetrazionePens p73:DetrazioneAltriRedditi p73:DetrazioneOneri p73:DetrazioneRistrutturazione p73:DetrazioniArredolmmobili p73:DetrazioneRisparmioEnergetico p73:DetrazioneArredoGiovaniCoppie p73:DetrazioneIvaAcquistoAbitaz p73:DetrazioneLocEAgricoliGiovani p73:AltreDetrazioni p73:DetrazioneCompartoSicurezza p73:DetrazionePaceContrRicarica p73:CreditoPrimaCasa p73:CreditoOccupazione p73:CreditoFondiPensione p73:CreditoMediazioni p73:CreditoNegoziazione p73:CreditoPrimaCasaU36 p73:CreditoContributoUnificato p73:TotaleDetrazioniCrediti
----------	--

element **Detrazione_Crediti_Type/DetrazioneConiuge**

diagram	
type	DatoNP_Type

element **Detrazione_Crediti_Type/DetrazioneFigli**

diagram	
type	DatoNP_Type

element **Detrazione_Crediti_Type/DetrazioneFamiliari**

diagram	
type	DatoNP_Type

element **Detrazione_Crediti_Type/DetrazioneLavDip**

diagram	
type	DatoNP_Type

element **Detrazione_Crediti_Type/DetrazionePens**

diagram	
type	DatoNP_Type

element **Detrazione_Crediti_Type/DetrazioneAltriRedditi**

diagram	
type	DatoNP_Type

element **Detrazione_Crediti_Type/DetrazioneOneri**

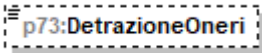
diagram	
type	DatoNP_Type

element **Detrazione_Crediti_Type/DetrazioneRistrutturazione**

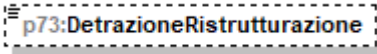
diagram	
type	DatoNP_Type

element **Detrazione_Crediti_Type/DetrazioniArredolmmobili**

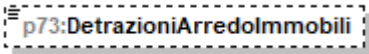
diagram	
type	DatoNP_Type

element **Detrazione_Crediti_Type/DetrazioneRisparmioEnergetico**

diagram	
type	DatoNP_Type

element **Detrazione_Crediti_Type/DetrazioneArredoGiovaniCoppie**

diagram	
type	DatoNP_Type

element **Detrazione_Crediti_Type/DetrazioneIvaAcquistoAbitaz**

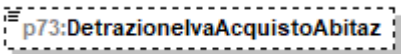
diagram	
type	DatoNP_Type

element **Detrazione_Crediti_Type/DetrazioneLocEAgricoliGiovani**

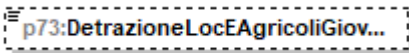
diagram	
---------	---

type	DatoNP_Type
------	-----------------------------

element **Detrazione_Crediti_Type/AltreDetrazioni**

diagram	
type	DatoNP_Type

element **Detrazione_Crediti_Type/DetrazioneCompartoSicurezza**

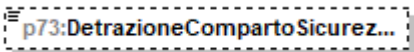
diagram	
type	DatoNP_Type

element **Detrazione_Crediti_Type/DetrazionePaceContrRicarica**

diagram	
type	DatoNP_Type

element **Detrazione_Crediti_Type/CreditoPrimaCasa**

diagram	
type	DatoNP_Type

element **Detrazione_Crediti_Type/CreditoOccupazione**

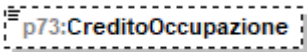
diagram	
type	DatoNP_Type

element **Detrazione_Crediti_Type/CreditoFondiPensione**

diagram	
type	DatoNP_Type

element **Detrazione_Crediti_Type/CreditoMediazioni**

diagram	
type	DatoNP_Type

element **Detrazione_Crediti_Type/CreditoNegoziazione**

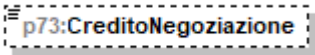
diagram	
type	DatoNP_Type

element **Detrazione_Crediti_Type/CreditoPrimaCasaU36**

diagram	
type	DatoNP_Type

element **Detrazione_Crediti_Type/CreditoContributoUnificato**

diagram	
type	DatoNP_Type

element **Detrazione_Crediti_Type/TotaleDetrazioniCrediti**

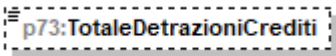
diagram	
type	DatoNP_Type

complexType **Detrazioni_Canoni_Locazione_Type**

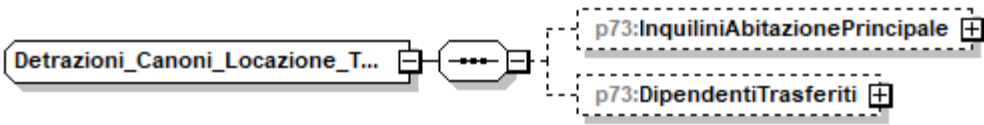
diagram	
children	p73:InquiliniAbitazionePrincipale p73:DipendentiTrasferiti

element **Detrazioni_Canoni_Locazione_Type/InquiliniAbitazionePrincipale**

diagram	
type	p73:Inquilini_Abitazione_Principale_Type
children	p73:Tipologia p73:GiorniPercentuale p73:Canone

element **Detrazioni_Canoni_Locazione_Type/DipendentiTrasferiti**

diagram	
type	p73:Giorni_Percentuale_Type
children	p73:Giorni p73:Percentuale

complexType **Detrazioni_Modulo_Type**

diagram	
children	p73:VeicoliDisabili p73:AcquistoCaniGuida p73:SpeseRateizzate p73:AltreSpese p73:SpeseLeasing

element **Detrazioni_Modulo_Type/VeicoliDisabili**

diagram	
type	p73:Spese_Rateizzate_Type
children	p73:Codice p73:Importo

element **Detrazioni_Modulo_Type/AcquistoCaniGuida**

diagram	
type	p73:Spese_Rateizzate_Type
children	p73:Codice p73:Importo

element **Detrazioni_Modulo_Type/SpeseRateizzate**

diagram	
type	p73:Spese_Rateizzate_Anni_Precedenti_Type
children	p73:Codice p73:Importo

element **Detrazioni_Modulo_Type/AltreSpese**

diagram	
type	p73:Altre_Spese_Type

children	p73:Codice p73:Importo
----------	--

element **Detrazioni_Modulo_Type/SpeseLeasing**

diagram	
type	p73:Spese_Leasing_Type
children	p73:DataStipula p73:NumeroAnno p73:Canone p73:PrezzoRiscatto

complexType **Detrazioni_Type**

diagram	
children	p73:CasellaRateazione p73:SpeseDeterminatePatologie p73:SpeseSanitarie p73:SpeseFamNonACarico p73:SpeseSanitarieDisabili p73:VeicoliDisabili p73:AcquistoCaniGuida p73:SpeseRateizzate p73:MutuiAbPrincipaleAnte p73:MutuiAbPrincipalePost p73:AltreSpese p73:SpeseLeasing

	p73:MutuiAbPrincipaleAnte p73:MutuiAbPrincipalePost p73:AltreSpese p73:SpeseLeasing
--	---

element **Detrazioni_Type/CasellaRateazione**

diagram	
type	DatoCB_Type

element **Detrazioni_Type/SpeseDeterminatePatologie**

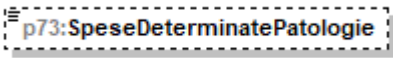
diagram	
type	DatoNP_Type

element **Detrazioni_Type/SpeseSanitarie**

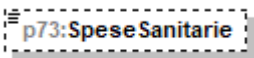
diagram	
type	DatoNP_Type

element **Detrazioni_Type/SpeseFamNonACarico**

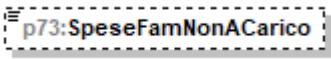
diagram	
type	DatoNP_Type

element **Detrazioni_Type/SpeseSanitarieDisabili**

diagram	
type	DatoNP_Type

element **Detrazioni_Type/VeicoliDisabili**

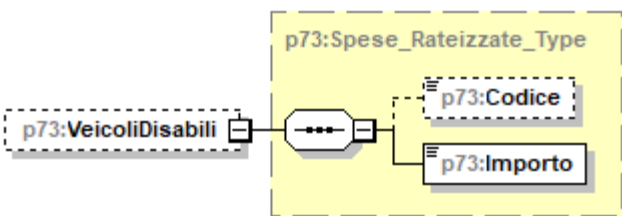
diagram	
type	p73:Spese_Rateizzate_Type

children	p73:Codice p73:Importo
----------	--

element **Detrazioni_Type/AcquistoCaniGuida**

diagram	
type	p73:Spese_Rateizzate_Type
children	p73:Codice p73:Importo

element **Detrazioni_Type/SpeseRateizzate**

diagram	
type	p73:Spese_Rateizzate_Anni_Precedenti_Type
children	p73:Codice p73:Importo

element **Detrazioni_Type/MutuiAbPrincipaleAnte**

diagram	
type	DatoNP_Type

element **Detrazioni_Type/MutuiAbPrincipalePost**

diagram	
type	DatoNP_Type

element **Detrazioni_Type/AltreSpese**

diagram	
type	p73:Altre_Spese_Type
children	p73:Codice p73:Importo

element **Detrazioni_Type/SpeseLeasing**

diagram	
type	p73:Spese_Leasing_Type
children	p73:DataStipula p73:NumeroAnno p73:Canone p73:PrezzoRiscatto

complexType **Documento_P73_Type**

diagram	
children	p73:Frontespizio p73:DatiContabili p73:EsitiContabili

element **Documento_P73_Type/Frontespizio**

<p>diagram</p>	
<p>type</p>	<p>p73:Frontespizio_730_Type</p>
<p>children</p>	<p>p73:SoggettoFiscale p73:DatiAnagrafici p73:DomicilioFiscaleSaldo p73:DomicilioFiscaleAcconto p73:CasiParticolariAddizionale</p>

element **Documento_P73_Type/DatiContabili**

<p>diagram</p>	
<p>type</p>	<p>p73:Dati_Contabili_Type</p>
<p>children</p>	<p>p73:Familiari p73:QuadroA p73:QuadroB p73:QuadroC p73:QuadroD p73:QuadroE p73:QuadroF p73:QuadroG p73:ProspettoLiquidazione p73:QuadroL p73:QuadroW</p>

element **Documento_P73_Type/EsitiContabili**

diagram	
children	p73:Conguaglio

element **Documento_P73_Type/EsitiContabili/Conguaglio**

diagram	
type	p73:Conguaglio_Type
children	p73:NumeroRate p73:ImportoTrattenutoSaldo p73:ImportoTrattenutoAcconto p73:ImportoDaVersareF24Saldo p73:ImportoDaVersareF24Acconto p73:ImportoRimborsato p73:ImportoRimborsatoAgenzia p73:OpzioneInformativa

complexType **Domanda_Accatastamento_Type**

diagram	
children	p73:Data p73:Numero p73:ProvinciaUfficio

element **Domanda_Accatamento_Type/Data**

diagram	
type	DatoDT_Type

element **Domanda_Accatamento_Type/Numero**

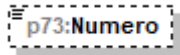
diagram	
type	DatoAN_Type

element **Domanda_Accatamento_Type/ProvinciaUfficio**

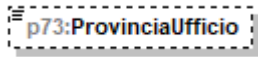
diagram	
type	PN_Type

complexType **Domicilio_Fiscale_Type**

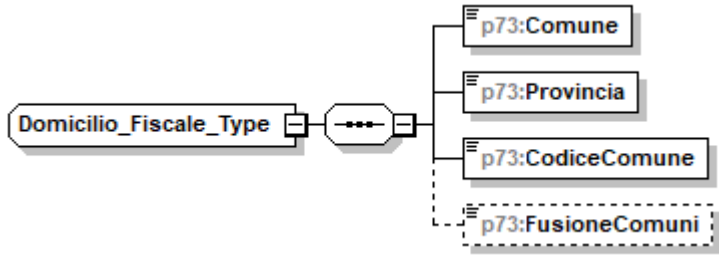
diagram	
children	p73:Comune p73:Provincia p73:CodiceComune p73:FusioneComuni

element **Domicilio_Fiscale_Type/Comune**

diagram	
type	DatoAN_Type

element **Domicilio_Fiscale_Type/Provincia**

diagram	
type	PR_Type

element **Domicilio_Fiscale_Type/CodiceComune**

diagram	
type	DatoAN_Type

element **Domicilio_Fiscale_Type/FusioneComuni**

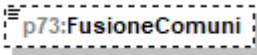
diagram	
type	DatoAN_Type

complexType **Eccedenze_Estero_Type**

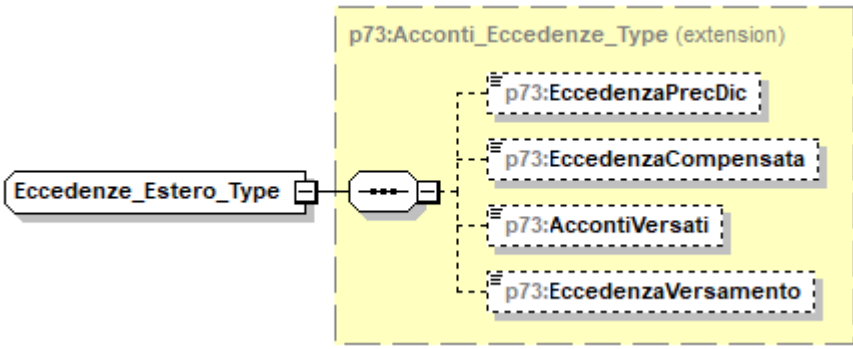
diagram	
type	extension of p73:Acconti_Eccedenze_Type
children	p73:EccedenzaPrecDic p73:EccedenzaCompensata p73:AccontiVersati p73:EccedenzaVersamento

complexType **Eccedenze_Oltre_Anno_Type**

<p>diagram</p>	
<p>children</p>	<p>p73:Anno p73:Irpef p73:SostitutivaQuadroRT p73:CedolareSecca p73:CodiceRegione p73:AddRegionaleIrpef p73:CodiceCatastaleComune p73:AddComunaleIrpef p73:ImpostaSostitutiva</p>

element **Eccedenze_Oltre_Anno_Type/Anno**

<p>diagram</p>	
<p>type</p>	<p>DatoDA_Type</p>

element **Eccedenze_Oltre_Anno_Type/Irpef**

<p>diagram</p>	
<p>type</p>	<p>DatoNP_Type</p>

element **Eccedenze_Oltre_Anno_Type/SostitutivaQuadroRT**

<p>diagram</p>	
<p>type</p>	<p>DatoNP_Type</p>

element **Eccedenze_Oltre_Anno_Type/CedolareSecca**

<p>diagram</p>	
----------------	--

type	DatoNP_Type
------	-----------------------------

element **Eccedenze_Oltre_Anno_Type/CodiceRegione**

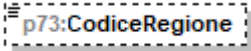
diagram																																													
type	Codice Regione Type																																												
facets	<table border="1"> <thead> <tr> <th>Kind</th> <th>Value</th> </tr> </thead> <tbody> <tr><td>enumeration</td><td>1</td></tr> <tr><td>enumeration</td><td>2</td></tr> <tr><td>enumeration</td><td>3</td></tr> <tr><td>enumeration</td><td>4</td></tr> <tr><td>enumeration</td><td>5</td></tr> <tr><td>enumeration</td><td>6</td></tr> <tr><td>enumeration</td><td>7</td></tr> <tr><td>enumeration</td><td>8</td></tr> <tr><td>enumeration</td><td>9</td></tr> <tr><td>enumeration</td><td>10</td></tr> <tr><td>enumeration</td><td>11</td></tr> <tr><td>enumeration</td><td>12</td></tr> <tr><td>enumeration</td><td>13</td></tr> <tr><td>enumeration</td><td>14</td></tr> <tr><td>enumeration</td><td>15</td></tr> <tr><td>enumeration</td><td>16</td></tr> <tr><td>enumeration</td><td>17</td></tr> <tr><td>enumeration</td><td>18</td></tr> <tr><td>enumeration</td><td>19</td></tr> <tr><td>enumeration</td><td>20</td></tr> <tr><td>enumeration</td><td>21</td></tr> </tbody> </table>	Kind	Value	enumeration	1	enumeration	2	enumeration	3	enumeration	4	enumeration	5	enumeration	6	enumeration	7	enumeration	8	enumeration	9	enumeration	10	enumeration	11	enumeration	12	enumeration	13	enumeration	14	enumeration	15	enumeration	16	enumeration	17	enumeration	18	enumeration	19	enumeration	20	enumeration	21
Kind	Value																																												
enumeration	1																																												
enumeration	2																																												
enumeration	3																																												
enumeration	4																																												
enumeration	5																																												
enumeration	6																																												
enumeration	7																																												
enumeration	8																																												
enumeration	9																																												
enumeration	10																																												
enumeration	11																																												
enumeration	12																																												
enumeration	13																																												
enumeration	14																																												
enumeration	15																																												
enumeration	16																																												
enumeration	17																																												
enumeration	18																																												
enumeration	19																																												
enumeration	20																																												
enumeration	21																																												

element **Eccedenze_Oltre_Anno_Type/AddRegionalelrpef**

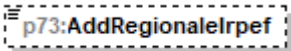
diagram	
type	DatoNP_Type

element **Eccedenze_Oltre_Anno_Type/CodiceCatastaleComune**

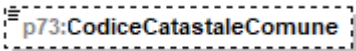
diagram	
type	restriction of DatoAN_Type

element **Eccedenze_Oltre_Anno_Type/AddComunalelrpef**

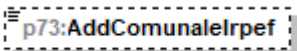
diagram	
type	DatoNP_Type

element **Eccedenze_Oltre_Anno_Type/ImpostaSostitutiva**

diagram	
type	DatoNP_Type

complexType **Eccedenze_Type**

diagram	
children	p73:Irpef p73:IrpefCompF24 p73:SostitutivaQuadroRT p73:SostitutivaQuadroRTCompF24 p73:CedolareSecca p73:CedolareSeccaCompF24 p73:CodiceRegione p73:AddRegionaleIrpef p73:AddRegionaleIrpefCompF24 p73:CodiceCatastaleComune p73:AddComunaleIrpef p73:AddComunaleIrpefF24 p73:PremioRisultato p73:PremioRisultatoCompF24

element **Eccedenze_Type/Irpef**

diagram	
type	DatoNP_Type

element **Eccedenze_Type/IrpefCompF24**

diagram	
type	DatoNP_Type

element **Eccedenze_Type/SostitutivaQuadroRT**

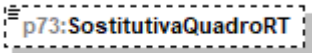
diagram	
type	DatoNP_Type

element **Eccedenze_Type/SostitutivaQuadroRTcompF24**

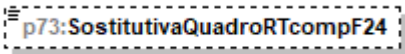
diagram	
type	DatoNP_Type

element **Eccedenze_Type/CedolareSecca**

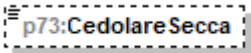
diagram	
type	DatoNP_Type

element **Eccedenze_Type/CedolareSeccaCompF24**

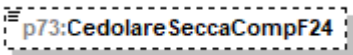
diagram	
type	DatoNP_Type

element **Eccedenze_Type/CodiceRegione**

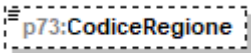
diagram																							
type	Codice Regione_Type																						
facets	<table border="1"> <thead> <tr> <th>Kind</th> <th>Value</th> </tr> </thead> <tbody> <tr><td>enumeration</td><td>1</td></tr> <tr><td>enumeration</td><td>2</td></tr> <tr><td>enumeration</td><td>3</td></tr> <tr><td>enumeration</td><td>4</td></tr> <tr><td>enumeration</td><td>5</td></tr> <tr><td>enumeration</td><td>6</td></tr> <tr><td>enumeration</td><td>7</td></tr> <tr><td>enumeration</td><td>8</td></tr> <tr><td>enumeration</td><td>9</td></tr> <tr><td>enumeration</td><td>10</td></tr> </tbody> </table>	Kind	Value	enumeration	1	enumeration	2	enumeration	3	enumeration	4	enumeration	5	enumeration	6	enumeration	7	enumeration	8	enumeration	9	enumeration	10
Kind	Value																						
enumeration	1																						
enumeration	2																						
enumeration	3																						
enumeration	4																						
enumeration	5																						
enumeration	6																						
enumeration	7																						
enumeration	8																						
enumeration	9																						
enumeration	10																						

	enumeration 11
	enumeration 12
	enumeration 13
	enumeration 14
	enumeration 15
	enumeration 16
	enumeration 17
	enumeration 18
	enumeration 19
	enumeration 20
	enumeration 21

element **Eccedenze_Type/AddRegionaleIrpef**

diagram	
type	DatoNP_Type

element **Eccedenze_Type/AddRegionaleIrpefCompF24**

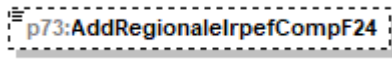
diagram	
type	DatoNP_Type

element **Eccedenze_Type/CodiceCatastaleComune**

diagram	
type	restriction of DatoAN_Type

element **Eccedenze_Type/AddComunaleIrpef**

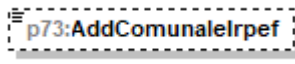
diagram	
type	DatoNP_Type

element **Eccedenze_Type/AddComunaleIrpefF24**

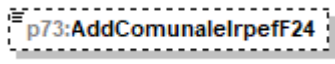
diagram	
type	DatoNP_Type

element **Eccedenze_Type/PremioRisultato**

diagram	
type	DatoNP_Type

element **Eccedenze_Type/PremioRisultatoCompF24**

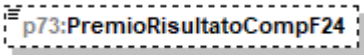
diagram	
type	DatoNP_Type

complexType **Elemento_Integrativo_Type**

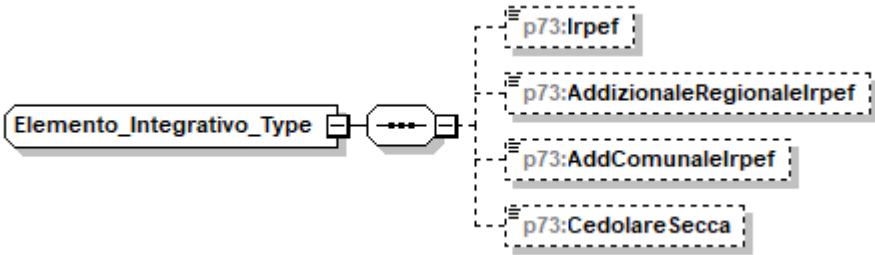
diagram	
children	p73:Irpef p73:AddizionaleRegionaleIrpef p73:AddComunaleIrpef p73:CedolareSecca

element **Elemento_Integrativo_Type/Irpef**

diagram	
type	DatoNP_Type

element **Elemento_Integrativo_Type/AddizionaleRegionaleIrpef**

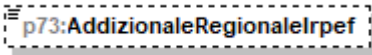
diagram	
type	DatoNP_Type

element **Elemento_Integrativo_Type/AddComunaleIrpef**

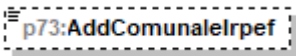
diagram	
type	DatoNP_Type

element **Elemento_Integrativo_Type/CedolareSecca**

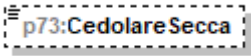
diagram	
type	DatoNP_Type

complexType **Erogazioni_Onlus_Type**

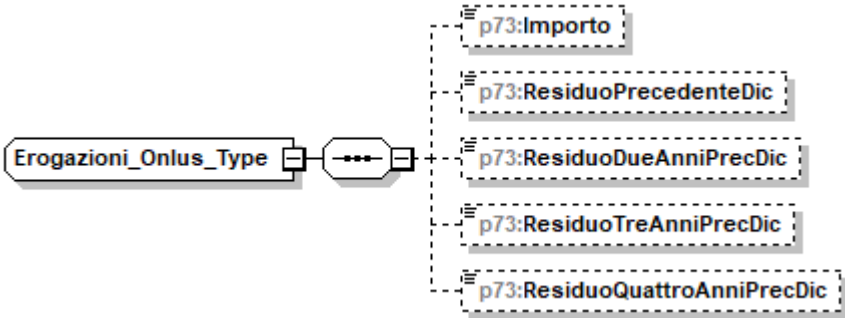
diagram	
children	p73:Importo p73:ResiduoPrecedenteDic p73:ResiduoDueAnniPrecDic p73:ResiduoTreAnniPrecDic p73:ResiduoQuattroAnniPrecDic

element **Erogazioni_Onlus_Type/Importo**

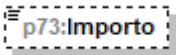
diagram	
type	DatoNP_Type

element **Erogazioni_Onlus_Type/ResiduoPrecedenteDic**

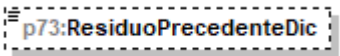
diagram	
type	DatoNP_Type

element **Erogazioni_Onlus_Type/ResiduoDueAnniPrecDic**

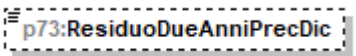
diagram	
type	DatoNP_Type

element **Erogazioni_Onlus_Type/ResiduoTreAnniPrecDic**

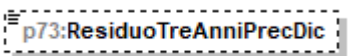
diagram	
type	DatoNP_Type

element **Erogazioni_Onlus_Type/ResiduoQuattroAnniPrecDic**

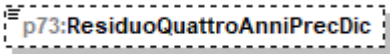
diagram	
type	DatoNP_Type

complexType **Esenzione_Add_Comunale_Type**

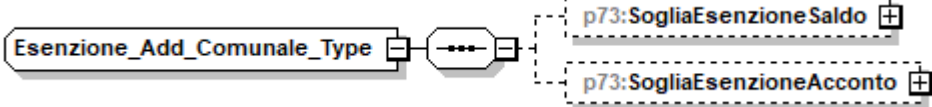
diagram	
children	p73:SogliaEsenzioneSaldo p73:SogliaEsenzioneAcconto

element **Esenzione_Add_Comunale_Type/SogliaEsenzioneSaldo**

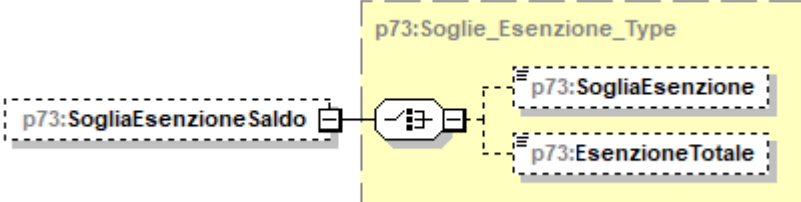
diagram	
type	p73:Soglie_Esenzione_Type
children	p73:SogliaEsenzione p73:EsenzioneTotale

element **Esenzione_Add_Comunale_Type/SogliaEsenzioneAcconto**

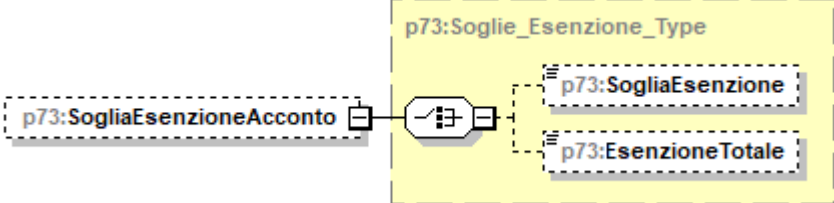
diagram	
type	p73:Soglie_Esenzione_Type
children	p73:SogliaEsenzione p73:EsenzioneTotale

complexType **Esito_Liquidazione_Type**

diagram	
children	<p>p73:Credito p73:Debito</p>

element **Esito_Liquidazione_Type/Credito**

diagram	
type	<p>p73:Credito_Type</p>
children	<p>p73:NonRimborsabile p73:Credito p73:CreditoF24 p73:CreditoRimborso</p>

element **Esito_Liquidazione_Type/Debito**

diagram	
type	<p>p73:Debito_Type</p>
children	<p>p73:NonVersare p73:ImportoDaTrattenere</p>

complexType **Esito_Sost_Type**

<p>diagram</p>	
<p>children</p>	<p>p73:ImpostaDovuta p73:EccedenzaPrecDic p73:AccontiVersati p73:ImpostaDebito p73:ImpostaCredito p73:EccedenzaVers p73:CreditoComp p73:Rimborso</p>

element **Esito_Sost_Type/ImpostaDovuta**

<p>diagram</p>	
<p>type</p>	<p>DatoNP_Type</p>

element **Esito_Sost_Type/EccedenzaPrecDic**

<p>diagram</p>	
<p>type</p>	<p>DatoNP_Type</p>

element **Esito_Sost_Type/AccontiVersati**

<p>diagram</p>	
<p>type</p>	<p>DatoNP_Type</p>

element **Esito_Sost_Type/ImpostaDebito**

<p>diagram</p>	
<p>type</p>	<p>DatoNP_Type</p>

element **Esito_Sost_Type/ImpostaCredito**

diagram	
type	DatoNP_Type

element **Esito_Sost_Type/EccedenzaVers**

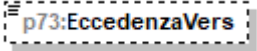
diagram	
type	DatoNP_Type

element **Esito_Sost_Type/CreditoComp**

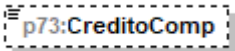
diagram	
type	DatoNP_Type

element **Esito_Sost_Type/Rimborso**

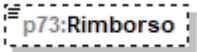
diagram	
type	DatoNP_Type

complexType **Fabbricato_Agev_Type**

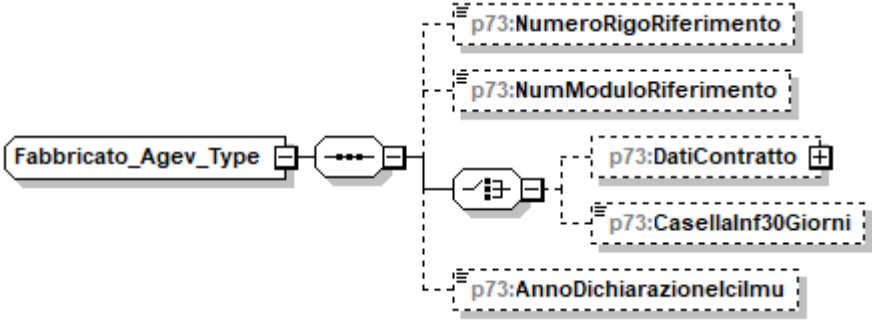
diagram	
children	p73:NumeroRigoRiferimento p73:NumModuloRiferimento p73:DatiContratto p73:CasellaInf30Giorni p73:AnnoDichiarazioneIcilmu

element **Fabbricato_Agev_Type/NumeroRigoRiferimento**

diagram	
---------	---

type	p73:Fabbricato_Agev_Numero_Rigo_Type	
facets	Kind	Value
	enumeration	1
	enumeration	2
	enumeration	3
	enumeration	4
	enumeration	5
	enumeration	6
	enumeration	7
	enumeration	8
	enumeration	9
	enumeration	10

element **Fabbricato_Agev_Type/NumModuloRiferimento**

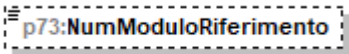
diagram	
type	DatoNP_Type

element **Fabbricato_Agev_Type/DatiContratto**

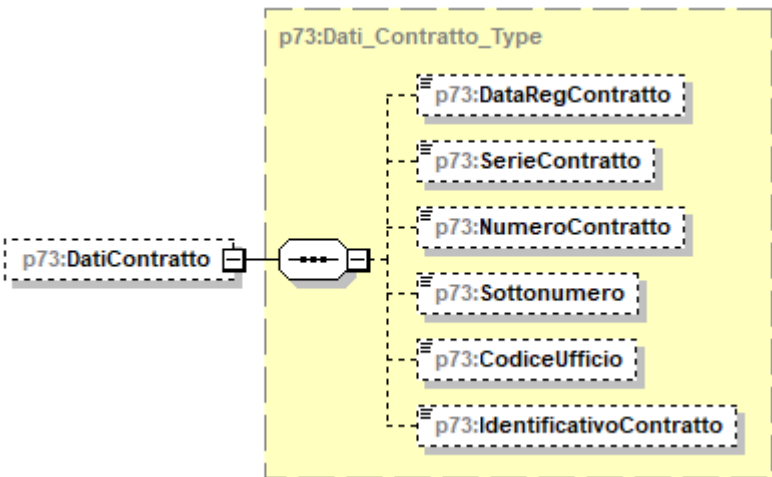
diagram	
type	p73:Dati_Contratto_Type
children	p73:DataRegContratto p73:SerieContratto p73:NumeroContratto p73:Sottonumero p73:CodiceUfficio p73:IdentificativoContratto

element **Fabbricato_Agev_Type/CasellaInf30Giorni**

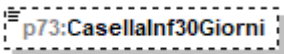
diagram	
type	DatoCB_Type

element **Fabbricato_Agev_Type/AnnoDichiarazioneIcilmu**

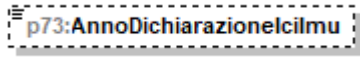
diagram	
type	DatoDA_Type

complexType **Fabbricato_Ord_Type**

diagram	
children	p73:Rendita p73:Utilizzo p73:GiorniPossesso p73:PercPossesso p73:CodiceCanone p73:CanoneLocazione p73:CasiParticolari p73:CasellaContinuazione p73:CodiceComune p73:OpzioneCedolare p73:CasellaCasiPartImu p73:AltriDati

element **Fabbricato_Ord_Type/Rendita**

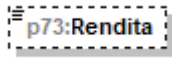
diagram	
type	DatoNP_Type

element **Fabbricato_Ord_Type/Utilizzo**

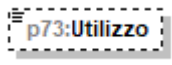
diagram	
type	restriction of p73:Utilizzo_Fabbricato_Type

facets	Kind	Value
	enumeration	1
	enumeration	2
	enumeration	3
	enumeration	4
	enumeration	5
	enumeration	8
	enumeration	9
	enumeration	10
	enumeration	11
	enumeration	12
	enumeration	14
	enumeration	15
	enumeration	16
	enumeration	17

element **Fabbricato_Ord_Type/GiorniPossesso**

diagram	
type	restriction of DatoNP_Type

element **Fabbricato_Ord_Type/PercPossesso**

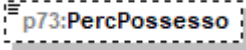
diagram	
type	DatoPC_Type

element **Fabbricato_Ord_Type/CodiceCanone**

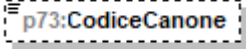
diagram		
type	p73:Codice Canone Type	
facets	Kind	Value
	enumeration	1
	enumeration	2
	enumeration	3
	enumeration	4

element **Fabbricato_Ord_Type/CanoneLocazione**

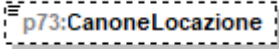
diagram	
type	DatoNP_Type

element **Fabbricato_Ord_Type/CasiParticolari**

diagram	
---------	---

type	p73:Casi Particolari Fabbricato Type	
facets	Kind	Value
	enumeration	1
	enumeration	3
	enumeration	4
	enumeration	5
	enumeration	6
	enumeration	7
	enumeration	8

element **Fabbricato_Ord_Type/CasellaContinuazione**

diagram	
type	DatoCB Type

element **Fabbricato_Ord_Type/CodiceComune**

diagram	
type	restriction of DatoAN Type

element **Fabbricato_Ord_Type/OpzioneCedolare**

diagram	
type	DatoCB Type

element **Fabbricato_Ord_Type/CasellaCasiPartImu**

diagram		
type	restriction of DatoN1 Type	
facets	Kind	Value
	enumeration	1
	enumeration	2
	enumeration	3

element **Fabbricato_Ord_Type/AltriDati**

diagram		
type	restriction of DatoN1 Type	
facets	Kind	Value
	enumeration	1
	enumeration	2

complexType **Familiari_Type**

<p>diagram</p>	
<p>children</p>	<p>p73:PrimoModulo p73:Modulo</p>

element **Familiari_Type/PrimoModulo**

<p>diagram</p>	
<p>type</p>	<p>p73:Primo_Modulo_Familiari_Type</p>
<p>children</p>	<p>p73:Coniuge p73:PrimoFiglio p73:Familiari p73:FigliAffidoPread</p>

element **Familiari_Type/Modulo**

<p>diagram</p>	
<p>type</p>	<p>p73:Modulo_Familiari_Type</p>
<p>children</p>	<p>p73:Coniuge p73:PrimoFiglio p73:Familiari</p>

complexType Fondo_Pensione_Dipendenti_Pubblici_Type

diagram	
children	p73:Contributi p73:QuotaTFR

element Fondo_Pensione_Dipendenti_Pubblici_Type/Contributi

diagram	
type	p73:Contributi Previdenza Complementare Type
children	p73:EsclusiDalSostituto p73:NonEsclusiDalSostituto

element Fondo_Pensione_Dipendenti_Pubblici_Type/QuotaTFR

diagram	
type	DatoNP_Type

complexType Frontespizio_730_Type

diagram	
children	p73:SoggettoFiscale p73:DatiAnagrafici p73:DomicilioFiscaleSaldo p73:DomicilioFiscaleAcconto p73:CasiParticolariAddizionale

element **Frontespizio_730_Type/SoggettoFiscale**

<p>diagram</p>	
<p>type</p>	<p>p73:Soggetto_Fiscale_730_Type</p>
<p>children</p>	<p>p73:CodiceFiscale p73:Email p73:Telefono p73:Cellulare</p>

element **Frontespizio_730_Type/DatiAnagrafici**

<p>diagram</p>	
<p>type</p>	<p>Dati_Anagrafici_Type</p>
<p>children</p>	<p>Cognome Nome Sesso DataNascita ComuneNascita ProvinciaNascita</p>

element **Frontespizio_730_Type/DomicilioFiscaleSaldo**

diagram	
type	p73:Domicilio_Fiscale_Type
children	p73:Comune p73:Provincia p73:CodiceComune p73:FusioneComuni

element **Frontespizio_730_Type/DomicilioFiscaleAcconto**

diagram	
type	p73:Domicilio_Fiscale_Type
children	p73:Comune p73:Provincia p73:CodiceComune p73:FusioneComuni

element **Frontespizio_730_Type/CasiParticolariAddizionale**

diagram							
type	restriction of DatoN1_Type						
facets	<table border="1"> <thead> <tr> <th>Kind</th> <th>Value</th> </tr> </thead> <tbody> <tr> <td>enumeration</td> <td>1</td> </tr> <tr> <td>enumeration</td> <td>2</td> </tr> </tbody> </table>	Kind	Value	enumeration	1	enumeration	2
Kind	Value						
enumeration	1						
enumeration	2						

complexType **Giorni_Percentuale_Type**

diagram	
---------	--

children	p73:Giorni p73:Percentuale
----------	--

element **Giorni_Percentuale_Type/Giorni**

diagram	
type	DatoNP_Type

element **Giorni_Percentuale_Type/Percentuale**

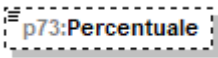
diagram	
type	DatoPC_Type

complexType **Imposta_Lorda_Type**

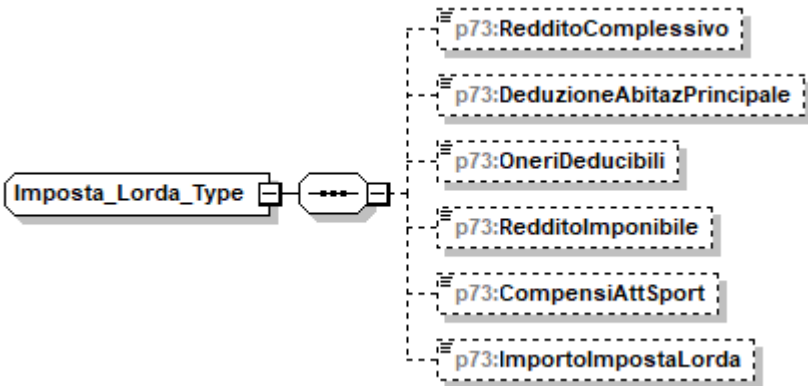
diagram	
children	p73:RedditoComplessivo p73:DeduzioneAbitazPrincipale p73:OneriDeducibili p73:RedditoImponibile p73:CompensiAttSport p73:ImportoImpostaLorda

element **Imposta_Lorda_Type/RedditoComplessivo**

diagram	
type	DatoNP_Type

element **Imposta_Lorda_Type/DeduzioneAbitazPrincipale**

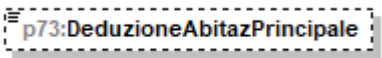
diagram	
type	DatoNP_Type

element **Imposta_Lorda_Type/OneriDeducibili**

diagram	
type	DatoNP_Type

element **Imposta_Lorda_Type/RedditolImponibile**

diagram	
type	DatoNP_Type

element **Imposta_Lorda_Type/CompensiAttSport**

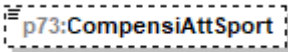
diagram	
type	DatoNP_Type

element **Imposta_Lorda_Type/ImportolImpostaLorda**

diagram	
type	DatoNP_Type

complexType **Imposta_Netta_Type**

<p>diagram</p>	
<p>children</p>	<p>p73:ImportoImpostaNetta p73:CredAltriSisma p73:CredAbitazSisma p73:CredImpEstere p73:CredErogCultura p73:CredErogScuola p73:CredVideosorveglianza p73:AltriCrediti p73:CredDetrazIncapienti p73:Ritenute p73:Differenza p73:EccedenzaIrf p73:AccontiVersati p73:CredRimborsatiSost p73:TrattamentoIntSpettante p73:TrattamentoIntRiconosciuto p73:RestituzioneTrattamentoInt</p>

element **Imposta_Netta_Type/ImportoImpostaNetta**

<p>diagram</p>	
<p>type</p>	<p>DatoNP_Type</p>

element **Imposta_Netta_Type/CredAltriSisma**

diagram	
type	DatoNP_Type

element **Imposta_Netta_Type/CredAbitazSisma**

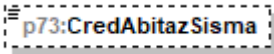
diagram	
type	DatoNP_Type

element **Imposta_Netta_Type/CredImpEstere**

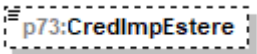
diagram	
type	DatoNP_Type

element **Imposta_Netta_Type/CredErogCultura**

diagram	
type	DatoNP_Type

element **Imposta_Netta_Type/CredErogScuola**

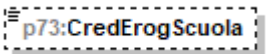
diagram	
type	DatoNP_Type

element **Imposta_Netta_Type/CredVideosorveglianza**

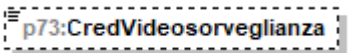
diagram	
type	DatoNP_Type

element **Imposta_Netta_Type/AltriCrediti**

diagram	
type	DatoNP_Type

element **Imposta_Netta_Type/CredDetrazIncapienti**

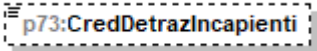
diagram	
type	DatoNP_Type

element **Imposta_Netta_Type/Ritenute**

diagram	
type	DatoNP_Type

element **Imposta_Netta_Type/Differenza**

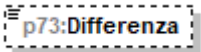
diagram	
type	DatoNU_Type

element **Imposta_Netta_Type/EccedenzaIrpef**

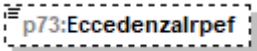
diagram	
type	DatoNU_Type

element **Imposta_Netta_Type/AccontiVersati**

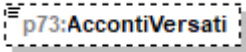
diagram	
type	DatoNP_Type

element **Imposta_Netta_Type/CredRimborsatiSost**

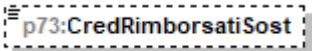
diagram	
type	DatoNP_Type

element **Imposta_Netta_Type/TrattamentoIntSpettante**

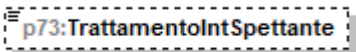
diagram	
type	DatoNP_Type

element **Imposta_Netta_Type/TrattamentoIntRiconosciuto**

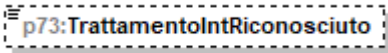
diagram	
type	DatoNP_Type

element **Imposta_Netta_Type/RestituzioneTrattamentoInt**

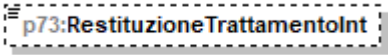
diagram	
type	DatoNP_Type

complexType **Imposte_Rimborsate_Type**

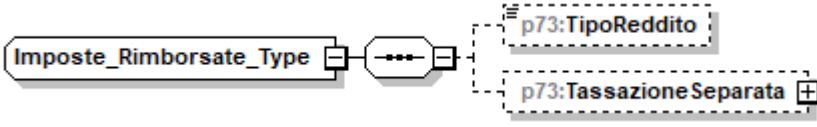
diagram	
children	p73:TipoReddito p73:TassazioneSeparata

element **Imposte_Rimborsate_Type/TipoReddito**

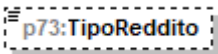
diagram																			
type	p73:Tipo Reddito Da1a8_Type																		
facets	<table border="1"> <thead> <tr> <th>Kind</th> <th>Value</th> </tr> </thead> <tbody> <tr><td>enumeration</td><td>1</td></tr> <tr><td>enumeration</td><td>2</td></tr> <tr><td>enumeration</td><td>3</td></tr> <tr><td>enumeration</td><td>4</td></tr> <tr><td>enumeration</td><td>5</td></tr> <tr><td>enumeration</td><td>6</td></tr> <tr><td>enumeration</td><td>7</td></tr> <tr><td>enumeration</td><td>8</td></tr> </tbody> </table>	Kind	Value	enumeration	1	enumeration	2	enumeration	3	enumeration	4	enumeration	5	enumeration	6	enumeration	7	enumeration	8
Kind	Value																		
enumeration	1																		
enumeration	2																		
enumeration	3																		
enumeration	4																		
enumeration	5																		
enumeration	6																		
enumeration	7																		
enumeration	8																		

element **Imposte_Rimborsate_Type/TassazioneSeparata**

diagram	
type	p73:TassazioneSeparata_Type
children	p73:Opzione p73:Anno p73:RedditoRitenute

complexType **Incremento_Produttivita_Type**

diagram	
children	p73:ImportoTassazOrdinaria p73:ImportoImpostaSostitutiva p73:RitenuteImpostaSostitutiva p73:Art51Ordinaria p73:Art51Sostitutiva p73:TassazOrdinaria p73:TassazSostitutiva

element **Incremento_Produttivita_Type/ImportoTassazOrdinaria**

diagram	
type	DatoNP_Type

element **Incremento_Produttivita_Type/ImportoImpostaSostitutiva**

diagram	
type	DatoNP_Type

element **Incremento_Produttivita_Type/RitenuteImpostaSostitutiva**

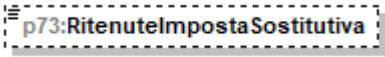
diagram	
type	DatoNP_Type

element **Incremento_Produttivita_Type/Art51Ordinaria**

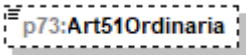
diagram	
type	DatoNP_Type

element **Incremento_Produttivita_Type/Art51Sostitutiva**

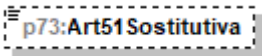
diagram	
type	DatoNP_Type

element **Incremento_Produttivita_Type/TassazOrdinaria**

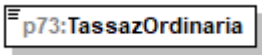
diagram	
type	DatoCB_Type

element **Incremento_Produttivita_Type/TassazSostitutiva**

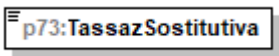
diagram	
type	DatoCB_Type

complexType **Inquilini_Abitazione_Principale_Type**

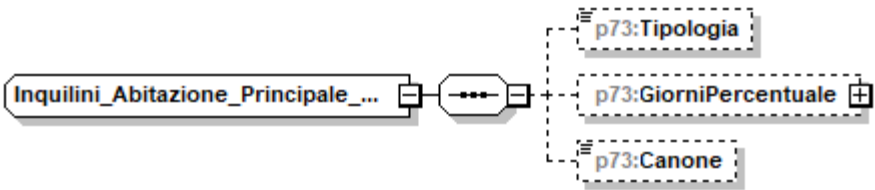
diagram	
children	p73:Tipologia p73:GiorniPercentuale p73:Canone

element **Inquilini_Abitazione_Principale_Type/Tipologia**

diagram									
type	p73:Tipo_Inquilino_Type								
facets	<table border="1"> <thead> <tr> <th>Kind</th> <th>Value</th> </tr> </thead> <tbody> <tr> <td>enumeration</td> <td>1</td> </tr> <tr> <td>enumeration</td> <td>2</td> </tr> <tr> <td>enumeration</td> <td>4</td> </tr> </tbody> </table>	Kind	Value	enumeration	1	enumeration	2	enumeration	4
Kind	Value								
enumeration	1								
enumeration	2								
enumeration	4								

element **Inquilini_Abitazione_Principale_Type/GiorniPercentuale**

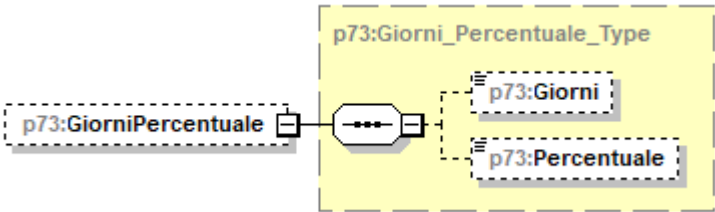
diagram	
type	p73:Giorni_Percentuale_Type
children	p73:Giorni p73:Percentuale

element **Inquilini_Abitazione_Principale_Type/Canone**

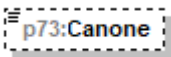
diagram	
type	DatoNP_Type

complexType **Intervento_Recupero_Patrimonio_Edilizio_Type**

<p>diagram</p>	
<p>children</p>	<p>p73:Anno p73:Periodo p73:CodiceFiscale p73:CasellaInterventiParticolari p73:CodiceSituazioniParticolari p73:MaggiorazioneSisma p73:Percentuale p73:Rate10 p73:Spesa p73:NOrdineImmobile</p>

element **Intervento_Recupero_Patrimonio_Edilizio_Type/Anno**

<p>diagram</p>																							
<p>type</p>	<p>restriction of p73:Anno_Recupero_Patrimonio_Edilizio_Type</p>																						
<p>facets</p>	<table border="1"> <thead> <tr> <th>Kind</th> <th>Value</th> </tr> </thead> <tbody> <tr><td>enumeration</td><td>2014</td></tr> <tr><td>enumeration</td><td>2015</td></tr> <tr><td>enumeration</td><td>2016</td></tr> <tr><td>enumeration</td><td>2017</td></tr> <tr><td>enumeration</td><td>2018</td></tr> <tr><td>enumeration</td><td>2019</td></tr> <tr><td>enumeration</td><td>2020</td></tr> <tr><td>enumeration</td><td>2021</td></tr> <tr><td>enumeration</td><td>2022</td></tr> <tr><td>enumeration</td><td>2023</td></tr> </tbody> </table>	Kind	Value	enumeration	2014	enumeration	2015	enumeration	2016	enumeration	2017	enumeration	2018	enumeration	2019	enumeration	2020	enumeration	2021	enumeration	2022	enumeration	2023
Kind	Value																						
enumeration	2014																						
enumeration	2015																						
enumeration	2016																						
enumeration	2017																						
enumeration	2018																						
enumeration	2019																						
enumeration	2020																						
enumeration	2021																						
enumeration	2022																						
enumeration	2023																						

element **Intervento_Recupero_Patrimonio_Edilizio_Type/Periodo**

<p>diagram</p>											
<p>type</p>	<p>p73:Periodo_Spese_Ristrutturazione_Type</p>										
<p>facets</p>	<table border="1"> <thead> <tr> <th>Kind</th> <th>Value</th> </tr> </thead> <tbody> <tr><td>enumeration</td><td>2</td></tr> <tr><td>enumeration</td><td>3</td></tr> <tr><td>enumeration</td><td>4</td></tr> <tr><td>enumeration</td><td>5</td></tr> </tbody> </table>	Kind	Value	enumeration	2	enumeration	3	enumeration	4	enumeration	5
Kind	Value										
enumeration	2										
enumeration	3										
enumeration	4										
enumeration	5										

enumeration	6
enumeration	7
enumeration	8
enumeration	9
enumeration	10
enumeration	11
enumeration	12
enumeration	13
enumeration	15
enumeration	16
enumeration	17
enumeration	18
enumeration	19
enumeration	20
enumeration	21
enumeration	22

element **Intervento_Ricupero_Patrimonio_Edilizio_Type/CodiceFiscale**

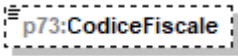
diagram	
type	DatoCF_Type

element **Intervento_Ricupero_Patrimonio_Edilizio_Type/CasellaInterventiParticolari**

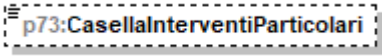
diagram							
type	restriction of DatoN1_Type						
facets	<table border="1"> <thead> <tr> <th>Kind</th> <th>Value</th> </tr> </thead> <tbody> <tr> <td>enumeration</td> <td>1</td> </tr> <tr> <td>enumeration</td> <td>4</td> </tr> </tbody> </table>	Kind	Value	enumeration	1	enumeration	4
Kind	Value						
enumeration	1						
enumeration	4						

element **Intervento_Ricupero_Patrimonio_Edilizio_Type/CodiceSituazioniParticolari**

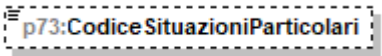
diagram					
type	p73:Casella_Codice_Type				
facets	<table border="1"> <thead> <tr> <th>Kind</th> <th>Value</th> </tr> </thead> <tbody> <tr> <td>enumeration</td> <td>4</td> </tr> </tbody> </table>	Kind	Value	enumeration	4
Kind	Value				
enumeration	4				

element **Intervento_Ricupero_Patrimonio_Edilizio_Type/MaggiorazioneSisma**

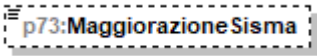
diagram	
type	DatoCB_Type

element **Intervento_Ricupero_Patrimonio_Edilizio_Type/Percentuale**

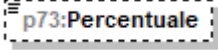
diagram							
type	restriction of DatoNP_Type						
facets	<table border="1"> <thead> <tr> <th>Kind</th> <th>Value</th> </tr> </thead> <tbody> <tr> <td>enumeration</td> <td>1</td> </tr> <tr> <td>enumeration</td> <td>2</td> </tr> </tbody> </table>	Kind	Value	enumeration	1	enumeration	2
Kind	Value						
enumeration	1						
enumeration	2						

element **Intervento_Ricupero_Patrimonio_Edilizio_Type/Rate10**

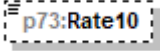
diagram																							
type	p73:Rate10_Type																						
facets	<table border="1"> <thead> <tr> <th>Kind</th> <th>Value</th> </tr> </thead> <tbody> <tr><td>enumeration</td><td>1</td></tr> <tr><td>enumeration</td><td>2</td></tr> <tr><td>enumeration</td><td>3</td></tr> <tr><td>enumeration</td><td>4</td></tr> <tr><td>enumeration</td><td>5</td></tr> <tr><td>enumeration</td><td>6</td></tr> <tr><td>enumeration</td><td>7</td></tr> <tr><td>enumeration</td><td>8</td></tr> <tr><td>enumeration</td><td>9</td></tr> <tr><td>enumeration</td><td>10</td></tr> </tbody> </table>	Kind	Value	enumeration	1	enumeration	2	enumeration	3	enumeration	4	enumeration	5	enumeration	6	enumeration	7	enumeration	8	enumeration	9	enumeration	10
Kind	Value																						
enumeration	1																						
enumeration	2																						
enumeration	3																						
enumeration	4																						
enumeration	5																						
enumeration	6																						
enumeration	7																						
enumeration	8																						
enumeration	9																						
enumeration	10																						

element **Intervento_Ricupero_Patrimonio_Edilizio_Type/Spesa**

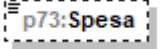
diagram	
type	DatoNP_Type

element **Intervento_Ricupero_Patrimonio_Edilizio_Type/NOrdineImmobile**

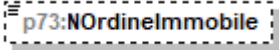
diagram	
type	DatoNP_Type

complexType **Intervento_Risparmio_Energetico_Type**

<p>diagram</p>	
<p>children</p>	<p>p73:TipoIntervento p73:Anno p73:CasiParticolari p73:RideterminazioneRate p73:Percentuale p73:NumeroRata p73:Spesa p73:MaggiorazioneSisma</p>

element **Intervento_Risparmio_Energetico_Type/TipolIntervento**

<p>diagram</p>																																											
<p>type</p>	<p>p73:Tipo Intervento Type</p>																																										
<p>facets</p>	<table border="1"> <thead> <tr> <th>Kind</th> <th>Value</th> </tr> </thead> <tbody> <tr><td>enumeration</td><td>1</td></tr> <tr><td>enumeration</td><td>2</td></tr> <tr><td>enumeration</td><td>3</td></tr> <tr><td>enumeration</td><td>4</td></tr> <tr><td>enumeration</td><td>5</td></tr> <tr><td>enumeration</td><td>6</td></tr> <tr><td>enumeration</td><td>7</td></tr> <tr><td>enumeration</td><td>8</td></tr> <tr><td>enumeration</td><td>9</td></tr> <tr><td>enumeration</td><td>10</td></tr> <tr><td>enumeration</td><td>11</td></tr> <tr><td>enumeration</td><td>12</td></tr> <tr><td>enumeration</td><td>13</td></tr> <tr><td>enumeration</td><td>14</td></tr> <tr><td>enumeration</td><td>15</td></tr> <tr><td>enumeration</td><td>16</td></tr> <tr><td>enumeration</td><td>30</td></tr> <tr><td>enumeration</td><td>31</td></tr> <tr><td>enumeration</td><td>32</td></tr> <tr><td>enumeration</td><td>33</td></tr> </tbody> </table>	Kind	Value	enumeration	1	enumeration	2	enumeration	3	enumeration	4	enumeration	5	enumeration	6	enumeration	7	enumeration	8	enumeration	9	enumeration	10	enumeration	11	enumeration	12	enumeration	13	enumeration	14	enumeration	15	enumeration	16	enumeration	30	enumeration	31	enumeration	32	enumeration	33
Kind	Value																																										
enumeration	1																																										
enumeration	2																																										
enumeration	3																																										
enumeration	4																																										
enumeration	5																																										
enumeration	6																																										
enumeration	7																																										
enumeration	8																																										
enumeration	9																																										
enumeration	10																																										
enumeration	11																																										
enumeration	12																																										
enumeration	13																																										
enumeration	14																																										
enumeration	15																																										
enumeration	16																																										
enumeration	30																																										
enumeration	31																																										
enumeration	32																																										
enumeration	33																																										

element **Intervento_Risparmio_Energetico_Type/Anno**

<p>diagram</p>	
<p>type</p>	<p>restriction of p73:Anno Risparmio Energetico Type</p>

facets	Kind	Value
	enumeration	2008
	enumeration	2014
	enumeration	2015
	enumeration	2016
	enumeration	2017
	enumeration	2018
	enumeration	2019
	enumeration	2020
	enumeration	2021
	enumeration	2022
	enumeration	2023

element **Intervento_Risparmio_Energetico_Type/CasiParticolari**

diagram		
type	p73:Casi Particolari Risp Ener Type	
facets	Kind	Value
	enumeration	1
	enumeration	2
	enumeration	3

element **Intervento_Risparmio_Energetico_Type/RideterminazioneRate**

diagram		
type	p73:Rate Risparmio Energetico Type	
facets	Kind	Value
	enumeration	6
	enumeration	7
	enumeration	8
	enumeration	9
	enumeration	10

element **Intervento_Risparmio_Energetico_Type/Percentuale**

diagram		
type	restriction of DatoNP_Type	
facets	Kind	Value
	enumeration	1
	enumeration	2

element **Intervento_Risparmio_Energetico_Type/NumeroRata**

diagram		
type	p73:Numero Rata Risparmio Energetico Type	
facets	Kind	Value
	enumeration	1
	enumeration	2

enumeration	3
enumeration	4
enumeration	5
enumeration	6
enumeration	7
enumeration	8
enumeration	9
enumeration	10

element **Intervento_Risparmio_Energetico_Type/Spesa**

diagram	
type	DatoNP_Type

element **Intervento_Risparmio_Energetico_Type/MaggiorazioneSisma**

diagram	
type	DatoCB_Type

complexType **Investimenti_Estero_Type**

diagram	
children	p73:PrimoModulo p73:Modulo

element **Investimenti_Estero_Type/PrimoModulo**

diagram	
type	p73:Primo Modulo Investimenti_Type
children	p73:Investimento p73:EccedenzeIvafe p73:EccedenzeIv p73:EccedenzeCripto

element **Investimenti_Estero_Type/Modulo**

<p>diagram</p>	<p>The diagram shows a class p73:Modulo with a multiplicity of $0..∞$ connected to a class p73:Investimento with a multiplicity of $0..5$. Both classes are enclosed within a dashed-line container labeled p73:Modulo_Investimenti_Type. The connection between the two classes is represented by a solid line with a small square on the p73:Modulo side and a small square with a plus sign on the p73:Investimento side.</p>
<p>type</p>	<p>p73:Modulo_Investimenti_Type</p>
<p>children</p>	<p>p73:Investimento</p>

complexType **Investimento_Type**

<p>diagram</p>	
<p>children</p>	<p>p73:TitoloPossesso p73:TipoContribuente p73:CodiceBene p73:CodiceStatoEstero p73:QuotaPossesso p73:Criterio p73:ValoreIniziale p73:ValoreFinale p73:ValoreMassimo p73:Giorni p73:Mesi p73:Credito p73:Detrazioni p73:Codice p73:QuotaPartecipazione p73:Monitoraggio p73:CodiceFiscale p73:CodiceFiscaleCoint p73:CodiceFiscaleCoint2 p73:CasellaCoint</p>

element **Investimento_Type/TitoloPossesso**

diagram	
type	DatoN1_Type

element **Investimento_Type/TipoContribuente**

diagram	
type	DatoN1_Type

element **Investimento_Type/CodiceBene**

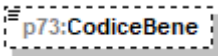
diagram	
type	DatoNP_Type

element **Investimento_Type/CodiceStatoEstero**

diagram	
type	DatoAN_Type

element **Investimento_Type/QuotaPossesso**

diagram	
type	DatoPC_Type

element **Investimento_Type/Criterio**

diagram	
type	DatoN1_Type

element **Investimento_Type/ValoreIniziale**

diagram	
type	DatoNP_Type

element **Investimento_Type/ValoreFinale**

diagram	
type	DatoNP_Type

element **Investimento_Type/ValoreMassimo**

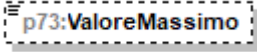
diagram	
type	DatoNP_Type

element **Investimento_Type/Giorni**

diagram	
type	DatoNP_Type

element **Investimento_Type/Mesi**

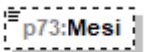
diagram	
type	DatoNP_Type

element **Investimento_Type/Credito**

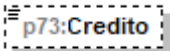
diagram	
type	DatoNP_Type

element **Investimento_Type/Detrazioni**

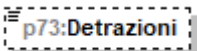
diagram	
type	DatoNP_Type

element **Investimento_Type/Codice**

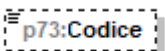
diagram	
type	DatoN1_Type

element **Investimento_Type/QuotaPartecipazione**

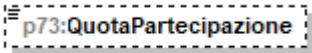
diagram	
type	DatoPC_Type

element **Investimento_Type/Monitoraggio**

diagram	
type	DatoCB_Type

element **Investimento_Type/CodiceFiscale**

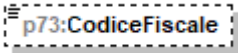
diagram	
type	DatoAN_Type

element **Investimento_Type/CodiceFiscaleCoint**

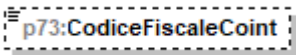
diagram	
type	DatoAN_Type

element **Investimento_Type/CodiceFiscaleCoint2**

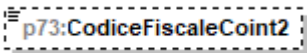
diagram	
type	DatoAN_Type

element **Investimento_Type/CasellaCoint**

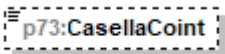
diagram	
type	DatoCB_Type

complexType Iva_Acquisto_Abitazione_Type

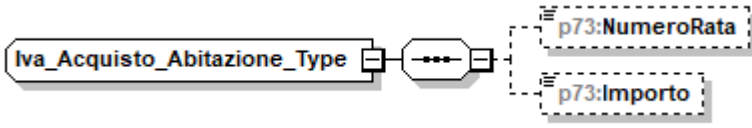
diagram	
children	p73:NumeroRata p73:Importo

element Iva_Acquisto_Abitazione_Type/NumeroRata

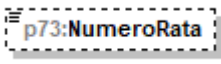
diagram									
type	restriction of DatoNP_Type								
facets	<table border="1"> <thead> <tr> <th>Kind</th> <th>Value</th> </tr> </thead> <tbody> <tr> <td>enumeration</td> <td>1</td> </tr> <tr> <td>enumeration</td> <td>7</td> </tr> <tr> <td>enumeration</td> <td>8</td> </tr> </tbody> </table>	Kind	Value	enumeration	1	enumeration	7	enumeration	8
Kind	Value								
enumeration	1								
enumeration	7								
enumeration	8								

element Iva_Acquisto_Abitazione_Type/Importo

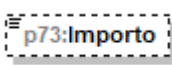
diagram	
type	DatoNP_Type

complexType Lavoro_Dipendente_Type

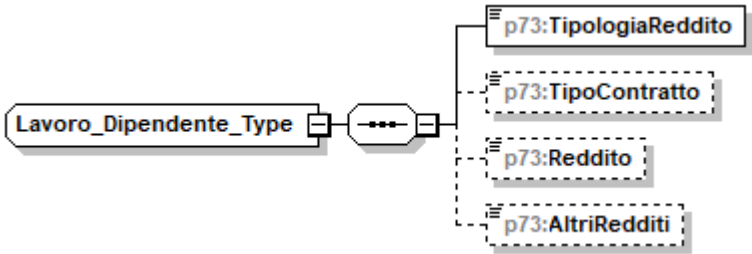
diagram	
children	p73:TipologiaReddito p73:TipoContratto p73:Reddito p73:AltriRedditi

element Lavoro_Dipendente_Type/TipologiaReddito

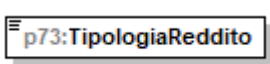
diagram													
type	restriction of DatoN1_Type												
facets	<table border="1"> <thead> <tr> <th>Kind</th> <th>Value</th> </tr> </thead> <tbody> <tr> <td>enumeration</td> <td>1</td> </tr> <tr> <td>enumeration</td> <td>2</td> </tr> <tr> <td>enumeration</td> <td>3</td> </tr> <tr> <td>enumeration</td> <td>4</td> </tr> <tr> <td>enumeration</td> <td>7</td> </tr> </tbody> </table>	Kind	Value	enumeration	1	enumeration	2	enumeration	3	enumeration	4	enumeration	7
Kind	Value												
enumeration	1												
enumeration	2												
enumeration	3												
enumeration	4												
enumeration	7												

	enumeration 8
	enumeration 9

element **Lavoro_Dipendente_Type/TipoContratto**

diagram							
type	p73:Indeterminato Determinato Type						
facets	<table border="1"> <thead> <tr> <th>Kind</th> <th>Value</th> </tr> </thead> <tbody> <tr> <td>enumeration</td> <td>1</td> </tr> <tr> <td>enumeration</td> <td>2</td> </tr> </tbody> </table>	Kind	Value	enumeration	1	enumeration	2
Kind	Value						
enumeration	1						
enumeration	2						

element **Lavoro_Dipendente_Type/Reddito**

diagram	
type	DatoNP Type

element **Lavoro_Dipendente_Type/AltriRedditi**

diagram											
type	restriction of DatoN1 Type										
facets	<table border="1"> <thead> <tr> <th>Kind</th> <th>Value</th> </tr> </thead> <tbody> <tr> <td>enumeration</td> <td>1</td> </tr> <tr> <td>enumeration</td> <td>2</td> </tr> <tr> <td>enumeration</td> <td>5</td> </tr> <tr> <td>enumeration</td> <td>6</td> </tr> </tbody> </table>	Kind	Value	enumeration	1	enumeration	2	enumeration	5	enumeration	6
Kind	Value										
enumeration	1										
enumeration	2										
enumeration	5										
enumeration	6										

complexType **Locazioni_Brevi_Type**

diagram	
children	p73:Ritenute

element **Locazioni_Brevi_Type/Ritenute**

diagram	
type	DatoNP Type

complexType Mance_Modulo_Type

diagram	
children	<p>p73:RedditoSettoreTuristico p73:ImportoTassazOrdinaria p73:ImportoImpostaSostitutiva p73:RitenuteImpostaSostitutiva</p>

element Mance_Modulo_Type/RedditoSettoreTuristico

diagram	
type	<p>DatoNP_Type</p>

element Mance_Modulo_Type/ImportoTassazOrdinaria

diagram	
type	<p>DatoNP_Type</p>

element Mance_Modulo_Type/ImportoImpostaSostitutiva

diagram	
type	<p>DatoNP_Type</p>

element Mance_Modulo_Type/RitenuteImpostaSostitutiva

diagram	
type	<p>DatoNP_Type</p>

complexType **Mance_Type**

<p>diagram</p>	
<p>type</p>	<p>extension of p73:Mance_Modulo_Type</p>
<p>children</p>	<p>p73:RedditoSettoreTuristico p73:ImportoTassazOrdinaria p73:ImportoImpostaSostitutiva p73:RitenuteImpostaSostitutiva p73:TassazOrdinaria p73:TassazSostitutiva p73:AssenzaRequisiti</p>

element **Mance_Type/TassazOrdinaria**

<p>diagram</p>	
<p>type</p>	<p>DatoCB_Type</p>

element **Mance_Type/TassazSostitutiva**

<p>diagram</p>	
<p>type</p>	<p>DatoCB_Type</p>

element **Mance_Type/AssenzaRequisiti**

<p>diagram</p>	
<p>type</p>	<p>DatoCB_Type</p>

complexType **Misura_Aconti_Type**

<p>diagram</p>	
<p>children</p>	<p>p73:IrpefMisuralInferiore p73:AddComunaleMisuralInferiore p73:CedolareSeccaMisuralInferiore p73:NumeroRate p73:CriptoAttMisuralInferiore p73:IvieMisuralInferiore p73:IvafeMisuralInferiore</p>

element **Misura_Aconti_Type/IrpefMisuralInferiore**

<p>diagram</p>	
<p>type</p>	<p>p73:Casella_Acconto_Type</p>
<p>children</p>	<p>p73:Casella p73:ImportoMisuralInferiore</p>

element **Misura_Aconti_Type/AddComunaleMisuralInferiore**

<p>diagram</p>	
<p>type</p>	<p>p73:Casella_Acconto_Type</p>
<p>children</p>	<p>p73:Casella p73:ImportoMisuralInferiore</p>

element **Misura_Acconti_Type/CedolareSeccaMisuralInferiore**

diagram	
type	p73:Casella_Acconto_Type
children	p73:Casella p73:ImportoMisuralInferiore

element **Misura_Acconti_Type/NumeroRate**

diagram															
type	restriction of DatoN1_Type														
facets	<table border="1"> <thead> <tr> <th>Kind</th> <th>Value</th> </tr> </thead> <tbody> <tr> <td>enumeration</td> <td>2</td> </tr> <tr> <td>enumeration</td> <td>3</td> </tr> <tr> <td>enumeration</td> <td>4</td> </tr> <tr> <td>enumeration</td> <td>5</td> </tr> <tr> <td>enumeration</td> <td>6</td> </tr> <tr> <td>enumeration</td> <td>7</td> </tr> </tbody> </table>	Kind	Value	enumeration	2	enumeration	3	enumeration	4	enumeration	5	enumeration	6	enumeration	7
Kind	Value														
enumeration	2														
enumeration	3														
enumeration	4														
enumeration	5														
enumeration	6														
enumeration	7														

element **Misura_Acconti_Type/CriptoAttMisuralInferiore**

diagram	
type	p73:Casella_Acconto_Type
children	p73:Casella p73:ImportoMisuralInferiore

element **Misura_Acconti_Type/lvieMisuralInferiore**

diagram	
type	p73:Casella_Acconto_Type

children	p73:Casella p73:ImportoMisuralInferiore
----------	---

element **Misura_Aconti_Type/IvafeMisuralInferiore**

diagram	
type	p73:Casella_Aconto_Type
children	p73:Casella p73:ImportoMisuralInferiore

complexType **Modulo_Altri_Reddi_Type**

diagram	
children	p73:RedditiDiCapitale p73:RedditiTassazioneSeparata

element **Modulo_Altri_Reddi_Type/RedditiDiCapitale**

diagram	
type	p73:Redditi_Capitale_Type
children	p73:Utili p73:AltriRedditiDiCapitale p73:LavoroAutonomo p73:RedditiDiversi p73:RedditiDiversiDetraz

element **Modulo_Altri_Reddit_Type/RedditiTassazioneSeparata**

diagram	
type	p73:Redditi_Tassazione_Separata_Type
children	p73:RedditiErede p73:ImposteRimborsate

complexType **Modulo_Crediti_Imposta_Type**

diagram	
children	p73:CreditiImpostaFondiPensione p73:CreditiImpostaRedditiEsteri p73:CreditoPrimaCasaSismaAbruzzo p73:CreditoAltriSismaAbruzzo p73:CreditoNegoziazione p73:AltriCreditiImposta

element **Modulo_Crediti_Imposta_Type/CreditiImpostaFondiPensione**

diagram	
type	p73:Crediti_Imposta_Fondi_Pensione_Type
children	p73:AnnoAnticipazione p73:Reintegro p73:SommaReintegrata p73:CreditoAnno

element **Modulo_Crediti_Imposta_Type/CreditiImpostaRedditiEsteri**

<p>diagram</p>	
<p>type</p>	<p>p73:Crediti_Imposta_Redditi_Esteri_Type</p>
<p>children</p>	<p>p73:StatoEstero p73:Anno p73:RedditoEstero p73:ImpostaEstera p73:RedditoComplessivo p73:Imposta_Lorda p73:ImpostaNetta p73:CreditoDichiarazioniPrecedenti p73:DiCuiStatoEstero</p>

element **Modulo_Crediti_Imposta_Type/CreditoPrimaCasaSismaAbruzzo**

<p>diagram</p>	
<p>type</p>	<p>p73:Credito_Immibile_Sisma_Abruzzo_Type</p>
<p>children</p>	<p>p73:CodiceFiscale p73:NumeroRata p73:TotaleCredito</p>

element **Modulo_Crediti_Imposta_Type/CreditoAltriSismaAbruzzo**

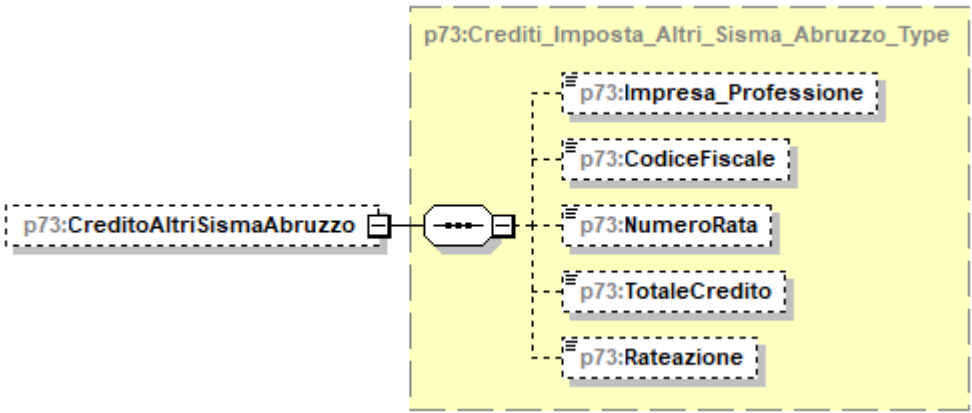
<p>diagram</p>	
<p>type</p>	<p>p73:Crediti_Imposta_Altri_Sisma_Abruzzo_Type</p>
<p>children</p>	<p>p73:Impresa_Professione p73:CodiceFiscale p73:NumeroRata p73:TotaleCredito p73:Rateazione</p>

element **Modulo_Crediti_Imposta_Type/CreditoNegoziazione**

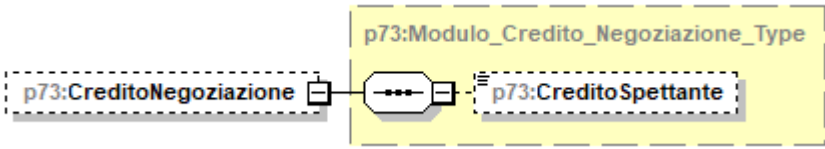
<p>diagram</p>	
<p>type</p>	<p>p73:Modulo_Credito_Negoziatore_Type</p>
<p>children</p>	<p>p73:CreditoSpettante</p>

element **Modulo_Crediti_Imposta_Type/AltriCreditiImposta**

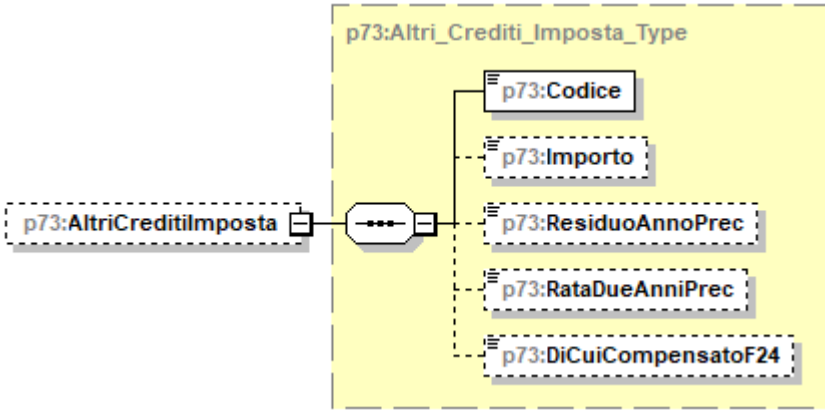
<p>diagram</p>	
<p>type</p>	<p>p73:Altri_Crediti_Imposta_Type</p>
<p>children</p>	<p>p73:Codice p73:Importo p73:ResiduoAnnoPrec p73:RataDueAnniPrec p73:DiCuiCompensatoF24</p>

complexType **Modulo_Credito_Negoziatore_Type**

diagram	
children	p73:CreditoSpettante

element **Modulo_Credito_Negoziatore_Type/CreditoSpettante**

diagram	
type	DatoNP_Type

complexType **Modulo_Fabbricato_Type**

diagram	
children	p73:FabbricatoOrd p73:FabbricatoAgev

element **Modulo_Fabbricato_Type/FabbricatoOrd**

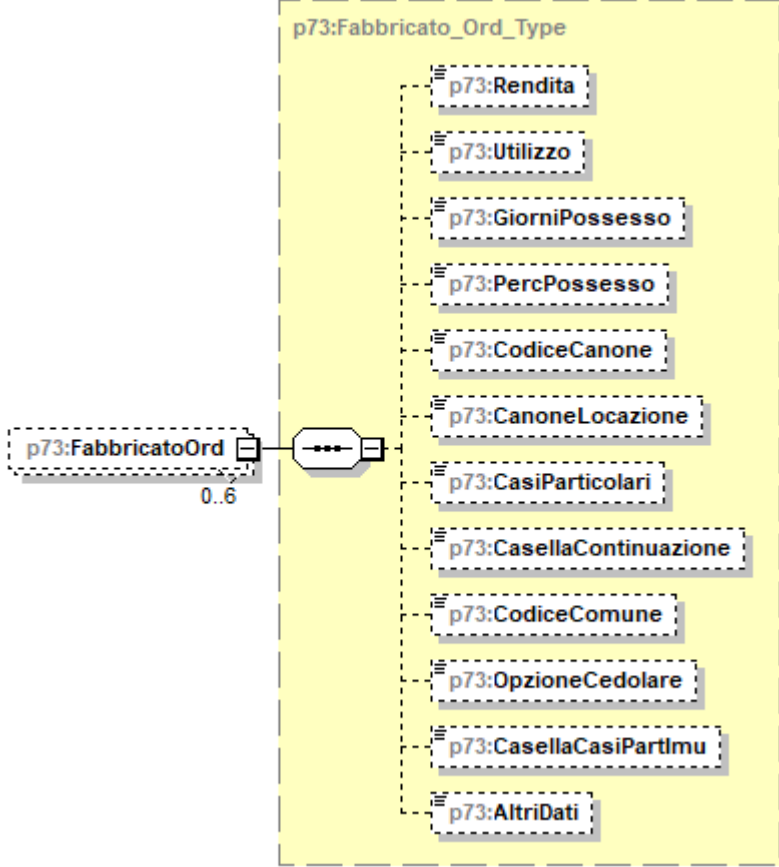
<p>diagram</p>	
<p>type</p>	<p>p73:Fabbricato_Ord_Type</p>
<p>children</p>	<p>p73:Rendita p73:Utilizzo p73:GiorniPossesso p73:PercPossesso p73:CodiceCanone p73:CanoneLocazione p73:CasiParticolari p73:CasellaContinuazione p73:CodiceComune p73:OpzioneCedolare p73:CasellaCasiPartimu p73:AltriDati</p>

element **Modulo_Fabbricato_Type/FabbricatoAgev**

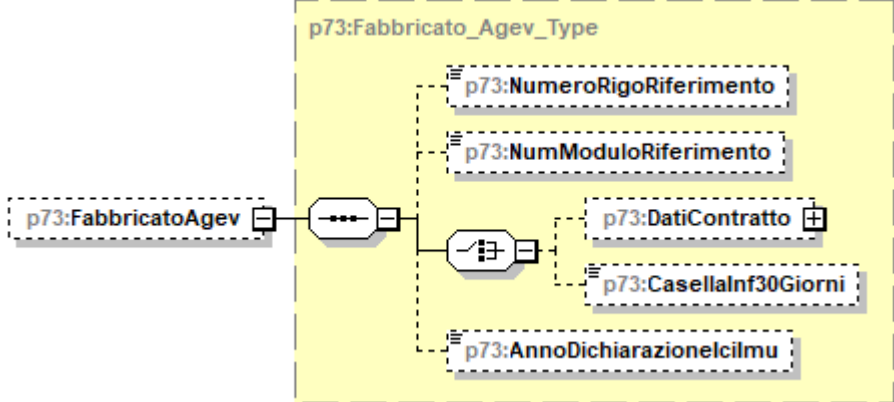
<p>diagram</p>	
<p>type</p>	<p>p73:Fabbricato_Agev_Type</p>

children	p73:NumeroRigoRiferimento p73:NumModuloRiferimento p73:DatiContratto p73:CasellaInf30Giorni p73:AnnoDichiarazioneIcilmu
----------	--

complexType **Modulo_Familiari_Type**

diagram	
children	p73:Coniuge p73:PrimoFiglio p73:Familiari

element **Modulo_Familiari_Type/Coniuge**

diagram	
type	p73:Dati_Coniuge_Type
children	p73:Tipo p73:CodiceFiscale p73:Mesi

element **Modulo_Familiari_Type/PrimoFiglio**

<p>diagram</p>	<p>The diagram shows a class p73:PrimoFiglio extending p73:Dati_Familiare_Type. The extension is highlighted in a yellow dashed box and includes the following elements: p73:CodiceFiscale, p73:Mesi, p73:PercDetraz, p73:PercDetrazCon, p73:Affidamento, p73:MesiDetraz21Anni, and p73:Tipo.</p>
<p>type</p>	<p>extension of p73:Dati_Familiare_Type</p>
<p>children</p>	<p>p73:CodiceFiscale p73:Mesi p73:PercDetraz p73:PercDetrazCon p73:Affidamento p73:MesiDetraz21Anni p73:Tipo</p>

element **Modulo_Familiari_Type/PrimoFiglio/Tipo**

<p>diagram</p>	<p>The diagram shows a class p73:Tipo which is a restriction of DatoAN_Type.</p>						
<p>type</p>	<p>restriction of DatoAN_Type</p>						
<p>facets</p>	<table border="1"> <thead> <tr> <th>Kind</th> <th>Value</th> </tr> </thead> <tbody> <tr> <td>enumeration</td> <td>F</td> </tr> <tr> <td>enumeration</td> <td>D</td> </tr> </tbody> </table>	Kind	Value	enumeration	F	enumeration	D
Kind	Value						
enumeration	F						
enumeration	D						

element **Modulo_Familiari_Type/Familiari**

diagram	
type	extension of p73:Dati_Familiare_Type
children	p73:CodiceFiscale p73:Mesi p73:PercDetraz p73:PercDetrazCon p73:Affidamento p73:MesiDetraz21Anni p73:Tipo

element **Modulo_Familiari_Type/Familiari/Tipo**

diagram									
type	restriction of DatoAN_Type								
facets	<table border="0"> <tr> <td>Kind</td> <td>Value</td> </tr> <tr> <td>enumeration</td> <td>F</td> </tr> <tr> <td>enumeration</td> <td>D</td> </tr> <tr> <td>enumeration</td> <td>A</td> </tr> </table>	Kind	Value	enumeration	F	enumeration	D	enumeration	A
Kind	Value								
enumeration	F								
enumeration	D								
enumeration	A								

complexType **Modulo_Investimenti_Type**

diagram	
children	p73:Investimento

element **Modulo_Investimenti_Type/Investimento**

<p>diagram</p>	
<p>type</p>	<p>p73:Investimento_Type</p>
<p>children</p>	<p>p73:TitoloPossesso p73:TipoContribuente p73:CodiceBene p73:CodiceStatoEstero p73:QuotaPossesso p73:Criterio p73:ValoreIniziale p73:ValoreFinale p73:ValoreMassimo p73:Giorni p73:Mesi p73:Credito p73:Detrazioni p73:Codice p73:QuotaPartecipazione p73:Monitoraggio p73:CodiceFiscale p73:CodiceFiscaleCoint p73:CodiceFiscaleCoint2 p73:CasellaCoint</p>

complexType **Modulo_Lavoro_Dip_Type**

diagram	
children	<p>p73:LavoroDipendente p73:PremiRisultato p73:AltriRedditiAssLavDip p73:Mance</p>

element **Modulo_Lavoro_Dip_Type/LavoroDipendente**

diagram	
type	<p>p73:Lavoro_Dipendente_Type</p>
children	<p>p73:TipologiaReddito p73:TipoContratto p73:Reddito p73:AltriRedditi</p>

element **Modulo_Lavoro_Dip_Type/PremiRisultato**

<p>diagram</p>	
<p>type</p>	<p>p73:Premi_Risultato_Modulo_Type</p>
<p>children</p>	<p>p73:TipoLimite p73:ImportoTassazOrdinaria p73:ImportoImpostaSostitutiva p73:RitenuteImpostaSostitutiva p73:Benefit p73:BenefitTassOrdinaria</p>

element **Modulo_Lavoro_Dip_Type/AltriRedditiAssLavDip**

<p>diagram</p>	
<p>type</p>	<p>p73:Altri_Redditi_Ass_Lav_Type</p>
<p>children</p>	<p>p73:AssegnoDelConiuge p73:ImportoRedditoAssimilato p73:AltriDati</p>

element **Modulo_Lavoro_Dip_Type/Mance**

<p>diagram</p>	
----------------	--

type	p73:Mance_Modulo_Type
children	p73:RedditoSettoreTuristico p73:ImportoTassazOrdinaria p73:ImportoImpostaSostitutiva p73:RitenuteImpostaSostitutiva

complexType **Modulo_Oneri_Type**

diagram	
children	p73:SpeseDetrazioni p73:SpeseDeduzioni p73:InterventoRecuperoPatrimonioEdilizio p73:DatiCatastaliRecuperoPatrimonioEdilizio p73:InterventoRisparmioEnergetico p73:CanoniLocazione p73:DatiAltreDetrazioni p73:SpeseArredo p73:SpeseArredoGiovani p73:IvaAcquistoAbitazione p73:SpesePaceContrRicarica

element **Modulo_Oneri_Type/SpeseDetrazioni**

<p>diagram</p>	
<p>type</p>	<p>p73:Detrazioni_Modulo_Type</p>
<p>children</p>	<p>p73:VeicoliDisabili p73:AcquistoCaniGuida p73:SpeseRateizzate p73:AltreSpese p73:SpeseLeasing</p>

element **Modulo_Oneri_Type/SpeseDeduzioni**

<p>diagram</p>	
<p>type</p>	<p>p73:Deduzioni_Modulo_Type</p>
<p>children</p>	<p>p73:AssegnoConiuge p73:AltriOneri p73:AcquistoCostruzioneAbitL...</p>

element **Modulo_Oneri_Type/InterventoRecuperoPatrimonioEdilizio**

<p>diagram</p>	
<p>type</p>	<p>p73:Intervento Ricupero Patrimonio Edilizio Type</p>
<p>children</p>	<p>p73:Anno p73:Periodo p73:CodiceFiscale p73:CasellaInterventiParticolari p73:CodiceSituazioniParticolari p73:MaggiorazioneSisma p73:Percentuale p73:Rate10 p73:Spesa p73:NOrdineImmobile</p>

element **Modulo_Oneri_Type/DatiCatastaliRecuperoPatrimonioEdilizio**

<p>diagram</p>	
<p>type</p>	<p>p73:Sezione Dati Catastali Ricupero Patrimonio Edilizio Type</p>
<p>children</p>	<p>p73:DatiCatastaliRecuperoPatrimonioEdilizio p73:DatiRegistrazioneAccatamentoRecuperoPatrimonio Edilizio</p>

element **Modulo_Oneri_Type/InterventoRisparmioEnergetico**

<p>diagram</p>	
<p>type</p>	<p>p73:Intervento_Risparmio_Energetico_Type</p>
<p>children</p>	<p>p73:TipoIntervento p73:Anno p73:CasiParticolari p73:RideterminazioneRate p73:Percentuale p73:NumeroRata p73:Spesa p73:MaggiorazioneSisma</p>

element **Modulo_Oneri_Type/CanoniLocazione**

<p>diagram</p>	
<p>type</p>	<p>p73:Detrazioni_Canoni_Locazione_Type</p>
<p>children</p>	<p>p73:InquiliniAbitazionePrincipale p73:DipendentiTrasferiti</p>

element **Modulo_Oneri_Type/DatiAltreDetrazioni**

<p>diagram</p>	
<p>type</p>	<p>p73:Dati_Altre_Detrazioni_Modulo_Type</p>
<p>children</p>	<p>p73:AltreDetrazioni</p>

element **Modulo_Oneri_Type/SpeseArredo**

diagram	
type	p73:Spese_Arredo_Type
children	p73:NumeroRata p73:Importo

element **Modulo_Oneri_Type/SpeseArredoGiovani**

diagram	
type	p73:Spese_Arredo_Giovani_Coppie_Type
children	p73:Meno35Anni p73:Importo

element **Modulo_Oneri_Type/IvaAcquistoAbitazione**

diagram	
type	p73:Iva_Acquisto_Abitazione_Type
children	p73:NumeroRata p73:Importo

element **Modulo_Oneri_Type/SpesePaceContrRicarica**

diagram	
type	p73:Spese_Laurea_Ricarica_Type
children	p73:Codice p73:Anno p73:Importo p73:Percentuale p73:Rata

complexType **Modulo_PL_Type**

diagram	
children	p73:CredImpEestero

element **Modulo_PL_Type/CredImpEestero**

diagram	
type	p73:Cred_Imp_Estero_Type
children	p73:Anno p73:TotCredito p73:CreditoStato

complexType **Modulo_Terreno_Type**

diagram	
children	p73:Terreno

element **Modulo_Terreno_Type/Terreno**

<p>diagram</p>	
<p>type</p>	<p>p73:Terreno_Type</p>
<p>children</p>	<p>p73:RedDominicale p73:Titolo p73:RedAgrario p73:GiorniPossesso p73:PercPossesso p73:CanoneVincolistico p73:CasiParticolari p73:CasellaContinuazione p73:CasellalmuNonDovuta p73:CasellaColtivatoreDiretto</p>

complexType **Modulo_Ulteriori_Dati_Type**

<p>diagram</p>	
<p>children</p>	<p>p73:RedditoCampione p73:RedditoCampioneFranchi p73:RivalutazioneTerreni p73:RedditiCapitaleSost</p>

element **Modulo_Ulteriori_Dati_Type/RedditoCampione**

diagram	
type	p73:Reddito_Campione_Type
children	p73:Codice p73:Importo

element **Modulo_Ulteriori_Dati_Type/RedditoCampioneFranchi**

diagram	
type	p73:Reddito_Campione_Franchi_Type
children	p73:Codice p73:Importo

element **Modulo_Ulteriori_Dati_Type/RivalutazioneTerreni**

diagram	
type	p73:Rivalutazione_Terreni_Type
children	p73:ValoreRivalutato p73:ImpostaDovuta p73:ImpostaVersata p73:ImpostaDaVersare p73:Rateizzazione p73:VersamentoCumulativo

element **Modulo_Ulteriori_Dati_Type/RedditiCapitaleSost**

<p>diagram</p>	
<p>type</p>	<p>p73:Redditi_Capitale_Sost_Type</p>
<p>children</p>	<p>p73:Tipo p73:CodiceStatoEstero p73:AmmontareReddito p73:Aliquota p73:Creditolvca p73:OpzioneOrdinaria p73:ProventiParticolari p73:EccedenzaVersamento</p>

complexType **N_Rate_Type**

<p>diagram</p>	
<p>children</p>	<p>p73:Rate5</p>

element **N_Rate_Type/Rate5**

<p>diagram</p>					
<p>type</p>	<p>p73:Rate5_Type</p>				
<p>facets</p>	<table border="1"> <tr> <td>Kind</td> <td>enumeration</td> <td>Value</td> <td>5</td> </tr> </table>	Kind	enumeration	Value	5
Kind	enumeration	Value	5		

complexType **Oneri_Non_Abbattuti_Type**

<p>diagram</p>	
<p>children</p>	<p>p73:DetrazSpeseAssPersonale p73:DetrazErogazBiennaleVenezia p73:DetrazErogazSpettacolo p73:DetrazErogazSettoreMusicale p73:DeduzContributiPaesiSviluppo p73:DeduzOnlus p73:DetrazOspedaleGalliera p73:InteressiMutuiAgrari p73:DeduzTrust p73:InteressiMutuiAgrari2022</p>

element **Oneri_Non_Abbattuti_Type/DetrazSpeseAssPersonale**

<p>diagram</p>	
<p>type</p>	<p>DatoNP_Type</p>

element **Oneri_Non_Abbattuti_Type/DetrazErogazBiennaleVenezia**

<p>diagram</p>	
<p>type</p>	<p>DatoNP_Type</p>

element **Oneri_Non_Abbattuti_Type/DetrazErogazSpettacolo**

<p>diagram</p>	
<p>type</p>	<p>DatoNP_Type</p>

element **Oneri_Non_Abbattuti_Type/DetrazErogazSettoreMusicale**

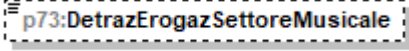
diagram	
type	DatoNP_Type

element **Oneri_Non_Abbattuti_Type/DeduzContributiPaesiSviluppo**

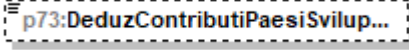
diagram	
type	DatoNP_Type

element **Oneri_Non_Abbattuti_Type/DeduzOnlus**

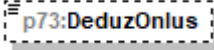
diagram	
type	DatoNP_Type

element **Oneri_Non_Abbattuti_Type/DetrazOspedaleGalliera**

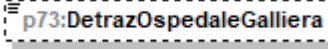
diagram	
type	DatoNP_Type

element **Oneri_Non_Abbattuti_Type/InteressiMutuiAgrari**

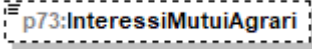
diagram	
type	DatoNP_Type

element **Oneri_Non_Abbattuti_Type/DeduzTrust**

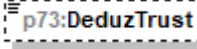
diagram	
type	DatoNP_Type

element **Oneri_Non_Abbattuti_Type/InteressiMutuiAgrari2022**

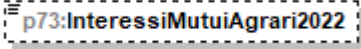
diagram	
type	DatoNP_Type

complexType **Oneri_Type**

<p>diagram</p>	
<p>children</p>	<p>p73:PrimoModulo p73:Modulo</p>

element **Oneri_Type/PrimoModulo**

<p>diagram</p>	
<p>type</p>	<p>p73:Primo Modulo Oneri Type</p>
<p>children</p>	<p>p73:SpeseDetrazioni p73:SpeseDeduzioni p73:InterventoRecuperoPatrimonioEdilizio p73:DatiCatastaliRecuperoPatrimonioEdilizio p73:InterventoRisparmioEnergetico p73:CanoniLocazione p73:DatiAltreDetrazioni p73:OneriNonAbbattuti p73:SpeseArredo p73:SpeseArredoGiovani p73:IvaAcquistoAbitazione p73:SpesePaceContrRicarica</p>

element **Oneri_Type/Modulo**

<p>diagram</p>	
<p>type</p>	<p>p73:Modulo_Oneri_Type</p>
<p>children</p>	<p>p73:SpeseDetrazioni p73:SpeseDeduzioni p73:InterventoRecuperoPatrimonioEdilizio p73:DatiCatastaliRecuperoPatrimonioEdilizio p73:InterventoRisparmioEnergetico p73:CanoniLocazione p73:DatiAltreDetrazioni p73:SpeseArredo p73:SpeseArredoGiovani p73:IvaAcquistoAbitazione p73:SpesePaceContrRicarica</p>

complexType **Opzione_Produttivita_Type**

<p>diagram</p>	
----------------	--

complexType **Periodo_Di_Lavoro_Type**

<p>diagram</p>	
----------------	--

children	p73:GiorniLavoroDipendente p73:GiorniPensione
----------	---

element **Periodo_Di_Lavoro_Type/GiorniLavoroDipendente**

diagram	
type	DatoGA_Type

element **Periodo_Di_Lavoro_Type/GiorniPensione**

diagram	
type	DatoGA_Type

complexType **Premi_Risultato_Modulo_Type**

diagram	
children	p73:TipoLimite p73:ImportoTassazOrdinaria p73:ImportoImpostaSostitutiva p73:RitenuteImpostaSostitutiva p73:Benefit p73:BenefitTassOrdinaria

element **Premi_Risultato_Modulo_Type/TipoLimite**

diagram							
type	restriction of DatoN1_Type						
facets	<table border="1"> <thead> <tr> <th>Kind</th> <th>Value</th> </tr> </thead> <tbody> <tr> <td>enumeration</td> <td>1</td> </tr> <tr> <td>enumeration</td> <td>2</td> </tr> </tbody> </table>	Kind	Value	enumeration	1	enumeration	2
Kind	Value						
enumeration	1						
enumeration	2						

element **Premi_Risultato_Modulo_Type/ImportoTassazOrdinaria**

diagram	
---------	--

type	DatoNP_Type
------	-----------------------------

element **Premi_Risultato_Modulo_Type/ImportoImpostaSostitutiva**

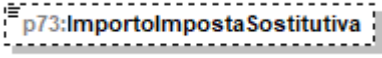
diagram	
type	DatoNP_Type

element **Premi_Risultato_Modulo_Type/RitenuteImpostaSostitutiva**

diagram	
type	DatoNP_Type

element **Premi_Risultato_Modulo_Type/Benefit**

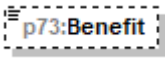
diagram	
type	DatoNP_Type

element **Premi_Risultato_Modulo_Type/BenefitTassOrdinaria**

diagram	
type	DatoNP_Type

complexType **Premi_Risultato_Type**

<p>diagram</p>	
<p>type</p>	<p>extension of p73:Premi_Risultato_Modulo_Type</p>
<p>children</p>	<p>p73:TipoLimite p73:ImportoTassazOrdinaria p73:ImportoImpostaSostitutiva p73:RitenuteImpostaSostitutiva p73:Benefit p73:BenefitTassOrdinaria p73:TassazOrdinaria p73:TassazSostitutiva p73:AssenzaRequisiti</p>

element **Premi_Risultato_Type/TassazOrdinaria**

<p>diagram</p>	
<p>type</p>	<p>DatoCB_Type</p>

element **Premi_Risultato_Type/TassazSostitutiva**

<p>diagram</p>	
<p>type</p>	<p>DatoCB_Type</p>

element **Premi_Risultato_Type/AssenzaRequisiti**

<p>diagram</p>	
<p>type</p>	<p>DatoCB_Type</p>

complexType **Primo_Modulo_Acconti_Ritenute_Type**

<p>diagram</p>	
<p>children</p>	<p>p73:Accontilrpef p73:AltreRitenute p73:Eccedenze p73:EccedenzeOltreAnno p73:RitenuteAccontiSospesi p73:MisuraAcconti p73:EsenzioneAddComunale p73:Dati730Integrativo p73:AccontiAltriDati p73:LocazioniBrevi</p>

element **Primo_Modulo_Acconti_Ritenute_Type/Accontilrpef**

<p>diagram</p>	
<p>type</p>	<p>p73:Acconti_Irpef_Anno_Imposta_Type</p>
<p>children</p>	<p>p73:PrimaRataAccontilrpef p73:SecondaRataAccontilrpef p73:AccontoAddComunale p73:PrimaRataAccontoCedolare p73:SecondaRataAccontoCedolare</p>

element **Primo_Modulo_Acconti_Ritenute_Type/AltreRitenute**

<p>diagram</p>	
<p>type</p>	<p>p73:Altre_Ritenute_Type</p>
<p>children</p>	<p>p73:Codice p73:AltreRitenuteIrpef p73:AddizionaleRegionale p73:AddizionaleComunale p73:AddRegionaleIrpefAttivitaSport p73:AddComunaleIrpefAttivitaSport p73:IrpefLavoriSocialmenteUtili p73:AddRegionaleIrpefLavoriSoc_Utili</p>

element **Primo_Modulo_Acconti_Ritenute_Type/Eccedenze**

<p>diagram</p>	
<p>type</p>	<p>p73:Eccedenze_Type</p>
<p>children</p>	<p>p73:Irpef p73:IrpefCompF24 p73:SostitutivaQuadroRT p73:SostitutivaQuadroRTcompF24 p73:CedolareSecca p73:CedolareSeccaCompF24 p73:CodiceRegione p73:AddRegionaleIrpef p73:AddRegionaleIrpefCompF24 p73:CodiceCatastaleComune p73:AddComunaleIrpef p73:AddComunaleIrpefF24 p73:PremioRisultato p73:PremioRisultatoCompF24</p>

element **Primo_Modulo_Acconti_Ritenute_Type/EccedenzeOltreAnno**

<p>diagram</p>	
<p>type</p>	<p>p73:Eccedenze Oltre Anno Type</p>
<p>children</p>	<p>p73:Anno p73:Irpef p73:SostitutivaQuadroRT p73:CedolareSecca p73:CodiceRegione p73:AddRegionaleIrpef p73:CodiceCatastaleComune p73:AddComunaleIrpef p73:ImpostaSostitutiva</p>

element **Primo_Modulo_Acconti_Ritenute_Type/RitenuteAccontiSospesi**

<p>diagram</p>	
<p>type</p>	<p>p73:Ritenute Acconti Sospesi Type</p>
<p>children</p>	<p>p73:CodiceEvento p73:Irpef p73:AddRegionaleIrpef p73:AddComunaleIrpef p73:SostitutivaPremi p73:CedolareSecca p73:SostitutivaRita</p>

element **Primo Modulo Acconti Ritenute Type/MisuraAcconti**

<p>diagram</p>	
<p>type</p>	<p>p73:Misura_Acconti_Type</p>
<p>children</p>	<p>p73:lrpefMisuralInferiore p73:AddComunaleMisuralInferiore p73:CedolareSeccaMisuralInferiore p73:NumeroRate p73:CriptoAttMisuralInferiore p73:lvieMisuralInferiore p73:lvafeMisuralInferiore</p>

element **Primo Modulo Acconti Ritenute Type/EsenzioneAddComunale**

<p>diagram</p>	
<p>type</p>	<p>p73:Esenzione_Add_Comunale_Type</p>
<p>children</p>	<p>p73:SogliaEsenzioneSaldo p73:SogliaEsenzioneAcconto</p>

element **Primo Modulo Acconti Ritenute Type/Dati730Integrativo**

<p>diagram</p>	
<p>type</p>	<p>p73:Dati_730_Integrativo_Type</p>

children	p73:Rimborso p73:Credito
----------	--

element **Primo Modulo Acconti Ritenute Type/AccontiAltriDati**

diagram	
type	p73:Acconti_Altri_Dati_Type
children	p73:IncapientiDetrazioneLocazione p73:Pignoramento

element **Primo Modulo Acconti Ritenute Type/LocazioniBrevi**

diagram	
type	p73:Locazioni_Brevi_Type
children	p73:Ritenute

complexType **Primo Modulo Crediti Imposta Type**

diagram	
children	p73:CreditImpostaFabbricati p73:CreditImpostaFondiPensione p73:CreditImpostaRedditiEsteri p73:CreditoPrimaCasaSismaAbruzzo p73:CreditoAltriSismaAbruzzo p73:CreditoPrimaCasaU36 p73:CreditoErogazioniCultura p73:AltriCreditImposta

element **Primo_Modulo_Crediti_Imposta_Type/CreditiImpostaFabbricati**

diagram	
type	p73:Crediti_Imposta_Fabbicati_Type
children	p73:ResiduoFabbricati p73:CanoniLocazioneNonPercepiti

element **Primo_Modulo_Crediti_Imposta_Type/CreditiImpostaFondiPensione**

diagram	
type	extension of p73:Crediti_Imposta_Fondi_Pensione_Type
children	p73:AnnoAnticipazione p73:Reintegro p73:SommaReintegrata p73:CreditoAnno p73:ResiduoPrecedenteDichiarazione p73:DiCuiCompensatoF24

element

Primo_Modulo_Crediti_Imposta_Type/CreditiImpostaFondiPensione/ResiduoPrecedenteDichiarazione

diagram	
type	DatoNP_Type

element **Primo_Modulo_Crediti_Imposta_Type/CreditiImpostaFondiPensione/DiCuiCompensatoF24**

diagram	
type	DatoNP_Type

element **Primo_Modulo_Crediti_Imposta_Type/CreditiImpostaRedditiEsteri**

<p>diagram</p>	
<p>type</p>	<p>p73:Crediti_Imposta_Redditi_Esteri_Type</p>
<p>children</p>	<p>p73:StatoEstero p73:Anno p73:RedditoEstero p73:ImpostaEstera p73:RedditoComplessivo p73:Imposta_Lorda p73:ImpostaNetta p73:CreditoDichiarazioniPrecedenti p73:DiCuiStatoEstero</p>

element **Primo_Modulo_Crediti_Imposta_Type/CreditoPrimaCasaSismaAbruzzo**

<p>diagram</p>	
<p>type</p>	<p>extension of p73:Credito_Immobilabile_Sisma_Abruzzo_Type</p>
<p>children</p>	<p>p73:CodiceFiscale p73:NumeroRata p73:TotaleCredito p73:ResiduoPrecedenteDichiarazione</p>

element **Primo_Modulo_Crediti_Imposta_Type/CreditoPrimaCasaSismaAbruzzo/ResiduoPrecedenteDichiarazio**

ne

diagram	
type	DatoNP_Type

element **Primo_Modulo_Crediti_Imposta_Type/CreditoAltriSismaAbruzzo**

diagram	
type	p73:Crediti_Imposta_Altri_Sisma_Abruzzo_Type
children	p73:Impresa_Professione p73:CodiceFiscale p73:NumeroRata p73:TotaleCredito p73:Rateazione

element **Primo_Modulo_Crediti_Imposta_Type/CreditoPrimaCasaU36**

diagram	
type	p73:Credito_Prima_Casa_U36
children	p73:ResiduoAnnoPrec p73:SpesaAnno p73:DiCuiCompensatoF24 p73:DiCuiCompensatoAtto

element **Primo_Modulo_Crediti_Imposta_Type/CreditoErogazioniCultura**

<p>diagram</p>	
<p>type</p>	<p>p73:Credito_Erogazioni_Cultura_Type</p>
<p>children</p>	<p>p73:SpesaAnno p73:ResiduoAnnoPrec p73:RataAnnoPrec p73:RataDueAnniPrec</p>

element **Primo_Modulo_Crediti_Imposta_Type/AltriCreditiImposta**

<p>diagram</p>	
<p>type</p>	<p>p73:Altri_Crediti_Imposta_Type</p>
<p>children</p>	<p>p73:Codice p73:Importo p73:ResiduoAnnoPrec p73:RataDueAnniPrec p73:DiCuiCompensatoF24</p>

complexType **Primo_Modulo_Familiari_Type**

<p>diagram</p>	
----------------	--

type	extension of p73:Modulo_Familiari_Type
children	p73:Coniuge p73:PrimoFiglio p73:Familiari p73:FigliAffidoPread

element **Primo_Modulo_Familiari_Type/FigliAffidoPread**

diagram	
type	DatoNP_Type

complexType **Primo_Modulo_Investimenti_Type**

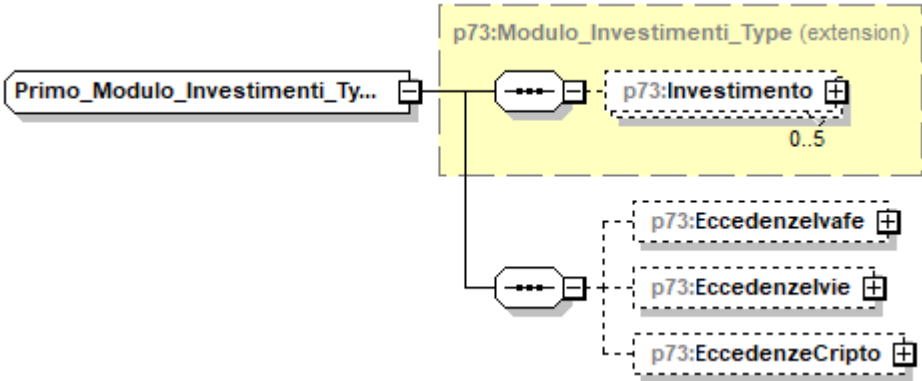
diagram	
type	extension of p73:Modulo_Investimenti_Type
children	p73:Investimento p73:Eccedenzelvafe p73:Eccedenzelvie p73:EccedenzeCripto

element **Primo_Modulo_Investimenti_Type/Eccedenzelvafe**

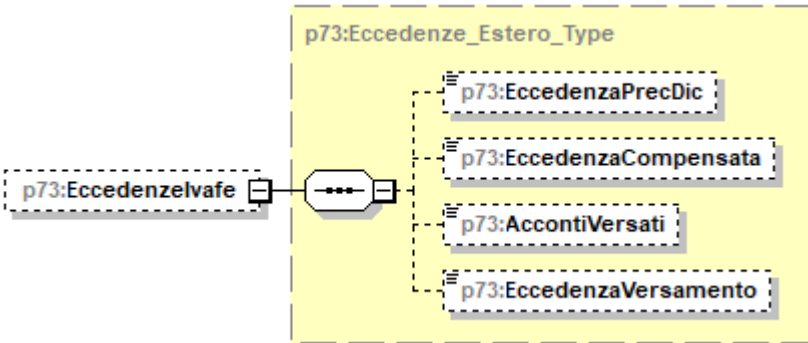
diagram	
type	p73:Eccedenze_Estero_Type
children	p73:EccedenzaPrecDic p73:EccedenzaCompensata p73:AccontiVersati p73:EccedenzaVersamento

element **Primo_Modulo_Investimenti_Type/EccedenzeIvie**

diagram	
type	p73:Eccedenze_Estero_Type
children	p73:EccedenzaPrecDic p73:EccedenzaCompensata p73:AccontiVersati p73:EccedenzaVersamento

element **Primo_Modulo_Investimenti_Type/EccedenzeCripto**

diagram	
children	p73:EccedenzaVersamento

element **Primo_Modulo_Investimenti_Type/EccedenzeCripto/EccedenzaVersamento**

diagram	
type	DatoNP_Type

complexType **Primo_Modulo_Lavoro_Dip_Type**

<p>diagram</p>	
<p>children</p>	<p>p73:LavoroDipendente p73:PremiRisultato p73:PeriodoLavoro p73:AltriRedditiAssLavDip p73:RitenuteLavoroDipendente p73:RiduzionePressioneFiscale p73:CasellaCasiParticolari p73:StatoEstero p73:CompartoSicurezza p73:Mance</p>

element **Primo_Modulo_Lavoro_Dip_Type/LavoroDipendente**

<p>diagram</p>	
<p>type</p>	<p>p73:Lavoro_Dipendente_Type</p>
<p>children</p>	<p>p73:TipologiaReddito p73:TipoContratto p73:Reddito p73:AltriRedditi</p>

element **Primo_Modulo_Lavoro_Dip_Type/PremiRisultato**

<p>diagram</p>	
<p>type</p>	<p>p73:Premi_Risultato_Type</p>
<p>children</p>	<p>p73:TipoLimite p73:ImportoTassazOrdinaria p73:ImportoImpostaSostitutiva p73:RitenuteImpostaSostitutiva p73:Benefit p73:BenefitTassOrdinaria p73:TassazOrdinaria p73:TassazSostitutiva p73:AssenzaRequisiti</p>

element **Primo_Modulo_Lavoro_Dip_Type/PeriodoLavoro**

<p>diagram</p>	
<p>type</p>	<p>p73:Periodo Di Lavoro_Type</p>
<p>children</p>	<p>p73:GiorniLavoroDipendente p73:GiorniPensione</p>

element **Primo_Modulo_Lavoro_Dip_Type/AltriRedditiAssLavDip**

<p>diagram</p>	
<p>type</p>	<p>p73:Altri Redditi Ass Lav Type</p>
<p>children</p>	<p>p73:AssegnoDelConiuge p73:ImportoRedditoAssimilato p73:AltriDati</p>

element **Primo_Modulo_Lavoro_Dip_Type/RitenuteLavoroDipendente**

<p>diagram</p>	
<p>type</p>	<p>p73:Ritenute Lavoro Dip Type</p>
<p>children</p>	<p>p73:Ritlrpef p73:RitRita p73:RitAddRegionale p73:RitAccAddComunale p73:RitSaldoAddComunale p73:RitAccAddComAnnoPres</p>

element **Primo_Modulo_Lavoro_Dip_Type/RiduzionePressioneFiscale**

<p>diagram</p>	
----------------	--

type	p73:Riduzione_Pressione_Type
children	p73:CodiceTrattamento p73:TrattamentoErogato p73:EsenzioneRicercatori p73:EsenzioneImpatriati

element **Primo_Modulo_Lavoro_Dip_Type/CasellaCasiParticolari**

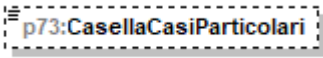
diagram																									
type	restriction of DatoNP_Type																								
facets	<table border="1"> <thead> <tr> <th>Kind</th> <th>Value</th> </tr> </thead> <tbody> <tr><td>enumeration</td><td>2</td></tr> <tr><td>enumeration</td><td>4</td></tr> <tr><td>enumeration</td><td>6</td></tr> <tr><td>enumeration</td><td>8</td></tr> <tr><td>enumeration</td><td>9</td></tr> <tr><td>enumeration</td><td>10</td></tr> <tr><td>enumeration</td><td>11</td></tr> <tr><td>enumeration</td><td>12</td></tr> <tr><td>enumeration</td><td>13</td></tr> <tr><td>enumeration</td><td>14</td></tr> <tr><td>enumeration</td><td>15</td></tr> </tbody> </table>	Kind	Value	enumeration	2	enumeration	4	enumeration	6	enumeration	8	enumeration	9	enumeration	10	enumeration	11	enumeration	12	enumeration	13	enumeration	14	enumeration	15
Kind	Value																								
enumeration	2																								
enumeration	4																								
enumeration	6																								
enumeration	8																								
enumeration	9																								
enumeration	10																								
enumeration	11																								
enumeration	12																								
enumeration	13																								
enumeration	14																								
enumeration	15																								

element **Primo_Modulo_Lavoro_Dip_Type/StatoEstero**

diagram	
type	DatoAN_Type

element **Primo_Modulo_Lavoro_Dip_Type/CompartoSicurezza**

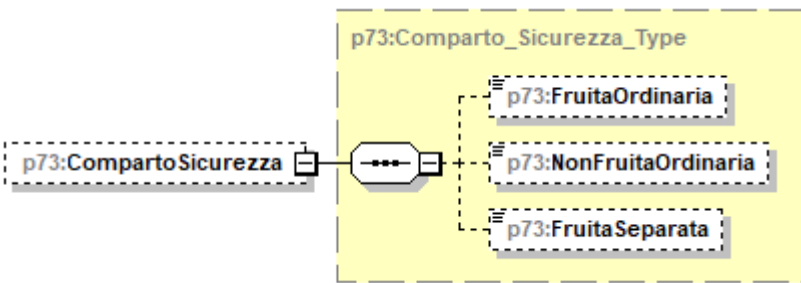
diagram	
type	p73:Comparto_Sicurezza_Type
children	p73:FruitaOrdinaria p73:NonFruitaOrdinaria p73:FruitaSeparata

element **Primo_Modulo_Lavoro_Dip_Type/Mance**

<p>diagram</p>	
<p>type</p>	<p>p73:Mance_Type</p>
<p>children</p>	<p>p73:RedditoSettoreTuristico p73:ImportoTassazOrdinaria p73:ImportoImpostaSostitutiva p73:RitenuteImpostaSostitutiva p73:TassazOrdinaria p73:TassazSostitutiva p73:AssenzaRequisiti</p>

complexType **Primo_Modulo_Oneri_Type**

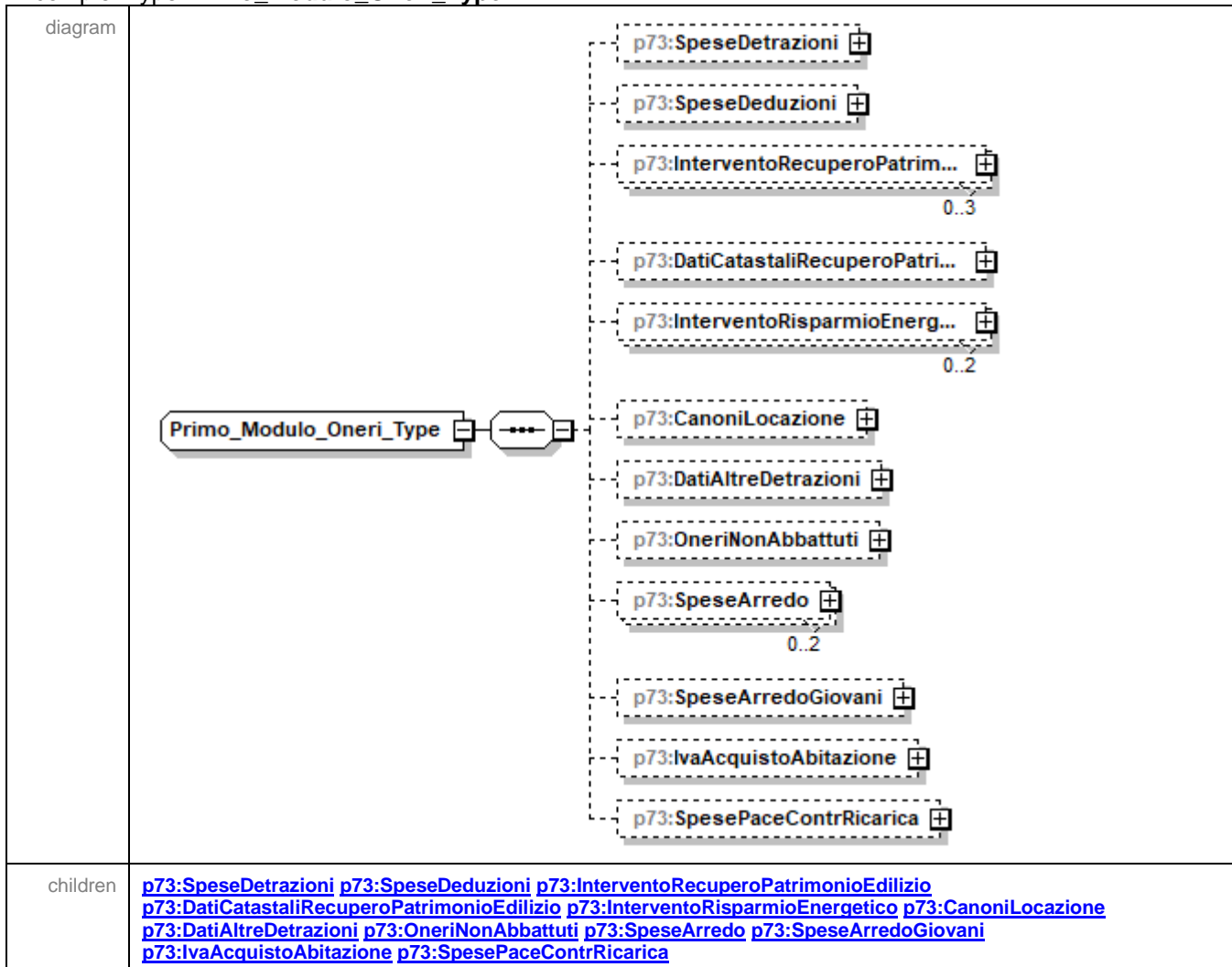

element **Primo_Modulo_Oneri_Type/SpeseDetrazioni**

<p>diagram</p>	
<p>type</p>	<p>p73:Detrazioni_Type</p>
<p>children</p>	<p>p73:CasellaRateazione p73:SpeseDeterminatePatologie p73:SpeseSanitarie p73:SpeseFamNonACarico p73:SpeseSanitarieDisabili p73:VeicoliDisabili p73:AcquistoCaniGuida p73:SpeseRateizzate p73:MutuiAbPrincipaleAnte p73:MutuiAbPrincipalePost p73:AltreSpese p73:SpeseLeasing</p>

element **Primo_Modulo_Oneri_Type/SpeseDeduzioni**

<p>diagram</p>	
<p>type</p>	<p>p73:Deduzioni_Type</p>
<p>children</p>	<p>p73:ContributiPrevAss p73:AssegnoConiuge p73:ContributiColf p73:ErogazioniIstituzioniReligiose p73:SpesePortatoriHandicap p73:AltriOneri p73:DeducibilitaOrdinaria p73:LavoratoriPrimaOccupazione p73:FondilnSquilibrioFinanziario p73:FamiliariACarico p73:AcquistoCostruzioneAbitL... p73:RestituzioneSomme p73:ErogazioniOnlus</p>

element **Primo_Modulo_Oneri_Type/InterventoRecuperoPatrimonioEdilizio**

<p>diagram</p>	
<p>type</p>	<p>p73:Intervento Ricupero Patrimonio Edilizio Type</p>
<p>children</p>	<p>p73:Anno p73:Periodo p73:CodiceFiscale p73:CasellaInterventiParticolari p73:CodiceSituazioniParticolari p73:MaggiorazioneSisma p73:Percentuale p73:Rate10 p73:Spesa p73:NOrdineImmobile</p>

element **Primo_Modulo_Oneri_Type/DatiCatastaliRecuperoPatrimonioEdilizio**

<p>diagram</p>	
<p>type</p>	<p>p73:Sezione Dati Catastali Ricupero Patrimonio Edilizio Type</p>
<p>children</p>	<p>p73:DatiCatastaliRecuperoPatrimonioEdilizio p73:DatiRegistrazioneAccatamentoRecuperoPatrimonio Edilizio</p>

element **Primo_Modulo_Oneri_Type/InterventoRisparmioEnergetico**

<p>diagram</p>	
<p>type</p>	<p>p73:Intervento_Risparmio_Energetico_Type</p>
<p>children</p>	<p>p73:TipoIntervento p73:Anno p73:CasiParticolari p73:RideterminazioneRate p73:Percentuale p73:NumeroRata p73:Spesa p73:MaggiorazioneSisma</p>

element **Primo_Modulo_Oneri_Type/CanoniLocazione**

<p>diagram</p>	
<p>type</p>	<p>p73:Detrazioni_Canoni_Locazione_Type</p>
<p>children</p>	<p>p73:InquiliniAbitazionePrincipale p73:DipendentiTrasferiti</p>

element **Primo_Modulo_Oneri_Type/DatiAltreDetrazioni**

<p>diagram</p>	
<p>type</p>	<p>p73:Dati_Altre_Detrazioni_Type</p>

children	p73:SpeseCaniGuida p73:AltreDetrazioni
----------	--

element **Primo Modulo Oneri_Type/OneriNonAbbattuti**

diagram	
type	p73:Oneri_Non_Abbattuti_Type
children	p73:DetrazSpeseAssPersonale p73:DetrazErogazBiennaleVenezia p73:DetrazErogazSpettacolo p73:DetrazErogazSettoreMusicale p73:DeduzContributiPaesiSviluppo p73:DeduzOnlus p73:DetrazOspedaleGalliera p73:InteressiMutuiAgrari p73:DeduzTrust p73:InteressiMutuiAgrari2022

element **Primo Modulo Oneri_Type/SpeseArredo**

diagram	
type	p73:Spese_Arredo_Type
children	p73:NumeroRata p73:Importo

element **Primo_Modulo_Oneri_Type/SpeseArredoGiovani**

diagram	
type	p73:Spese_Arredo_Giovani_Coppie_Type
children	p73:Meno35Anni p73:Importo

element **Primo_Modulo_Oneri_Type/IvaAcquistoAbitazione**

diagram	
type	p73:Iva_Acquisto_Abitazione_Type
children	p73:NumeroRata p73:Importo

element **Primo_Modulo_Oneri_Type/SpesePaceContrRicarica**

diagram	
type	p73:Spese_Laurea_Ricarica_Type
children	p73:Codice p73:Anno p73:Importo p73:Percentuale p73:Rata

complexType **Primo_Modulo_PL_Type**

diagram	
children	p73:Prospetto p73:ProspettoRideterminato

element **Primo_Modulo_PL_Type/Prospetto**

diagram	
type	extension of p73:Prospetto_Type
children	p73:RiepilogoRedditi p73:ImpostaLorda p73:DetrazioniCrediti p73:ImpostaNetta p73:Addizionali p73:CedolareSecca p73:LiquidazioneImposte p73:AltriDati p73:CredImpEstero p73:DatiCreditiF24 p73:LiquidazioneImposteSost

element **Primo_Modulo_PL_Type/Prospetto/Addizionali**

<p>diagram</p>	
<p>type</p>	<p>p73:Addizionali_Type</p>
<p>children</p>	<p>p73:Imponibile p73:AddRegDovuta p73:AddRegCertif p73:EccedenzaAddReg p73:AddComDovuta p73:AddComCertif p73:EccedenzaAddCom p73:AccontoAddCom p73:AccontoAddComCertif</p>

element **Primo_Modulo_PL_Type/Prospetto/CedolareSecca**

<p>diagram</p>	
<p>type</p>	<p>p73:Cedolare_Secca_Type</p>
<p>children</p>	<p>p73:CedolareDovuta p73:EccedenzaCedolareSecca p73:AccontoCedolare</p>

element **Primo_Modulo_PL_Type/Prospetto/LiquidazioneImposte**

<p>diagram</p>	
<p>children</p>	<p>p73:EsitoIrpef p73:EsitoAddRegionale p73:EsitoAddComunale p73:PrimaRataAcclrpef p73:SecondaRataAcclrpef p73:AccontoTassSep p73:AccontoAddComunale p73:ImpostaSostitutiva p73:EsitoCedolareSecca p73:PrimaRataAccCedolare p73:SecondaRataAccCedolare</p>

element **Primo_Modulo_PL_Type/Prospetto/LiquidazioneImposte/EsitoIrpef**

<p>diagram</p>	
<p>type</p>	<p>p73:Esito_Liquidazione_Type</p>
<p>children</p>	<p>p73:Credito p73:Debito</p>

element **Primo_Modulo_PL_Type/Prospetto/LiquidazioneImposte/EsitoAddRegionale**

diagram	
type	extension of p73:Esito_Liquidazione_Type
children	p73:Credito p73:Debito p73:CodAddReg

element **Primo_Modulo_PL_Type/Prospetto/LiquidazioneImposte/EsitoAddRegionale/CodAddReg**

diagram																																													
type	Codice Regione Type																																												
facets	<table border="1"> <thead> <tr> <th>Kind</th> <th>Value</th> </tr> </thead> <tbody> <tr><td>enumeration</td><td>1</td></tr> <tr><td>enumeration</td><td>2</td></tr> <tr><td>enumeration</td><td>3</td></tr> <tr><td>enumeration</td><td>4</td></tr> <tr><td>enumeration</td><td>5</td></tr> <tr><td>enumeration</td><td>6</td></tr> <tr><td>enumeration</td><td>7</td></tr> <tr><td>enumeration</td><td>8</td></tr> <tr><td>enumeration</td><td>9</td></tr> <tr><td>enumeration</td><td>10</td></tr> <tr><td>enumeration</td><td>11</td></tr> <tr><td>enumeration</td><td>12</td></tr> <tr><td>enumeration</td><td>13</td></tr> <tr><td>enumeration</td><td>14</td></tr> <tr><td>enumeration</td><td>15</td></tr> <tr><td>enumeration</td><td>16</td></tr> <tr><td>enumeration</td><td>17</td></tr> <tr><td>enumeration</td><td>18</td></tr> <tr><td>enumeration</td><td>19</td></tr> <tr><td>enumeration</td><td>20</td></tr> <tr><td>enumeration</td><td>21</td></tr> </tbody> </table>	Kind	Value	enumeration	1	enumeration	2	enumeration	3	enumeration	4	enumeration	5	enumeration	6	enumeration	7	enumeration	8	enumeration	9	enumeration	10	enumeration	11	enumeration	12	enumeration	13	enumeration	14	enumeration	15	enumeration	16	enumeration	17	enumeration	18	enumeration	19	enumeration	20	enumeration	21
Kind	Value																																												
enumeration	1																																												
enumeration	2																																												
enumeration	3																																												
enumeration	4																																												
enumeration	5																																												
enumeration	6																																												
enumeration	7																																												
enumeration	8																																												
enumeration	9																																												
enumeration	10																																												
enumeration	11																																												
enumeration	12																																												
enumeration	13																																												
enumeration	14																																												
enumeration	15																																												
enumeration	16																																												
enumeration	17																																												
enumeration	18																																												
enumeration	19																																												
enumeration	20																																												
enumeration	21																																												

element **Primo_Modulo_PL_Type/Prospetto/LiquidazioneImposte/EsitoAddComunale**

diagram	
---------	--

type	extension of p73:Esito_Liquidazione_Type
children	p73:Credito p73:Debito p73:CodiceAddCom

element **Primo_Modulo_PL_Type/Prospetto/LiquidazioneImposte/EsitoAddComunale/CodiceAddCom**

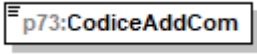
diagram	
type	DatoAN_Type

element **Primo_Modulo_PL_Type/Prospetto/LiquidazioneImposte/PrimaRataAcclrpef**

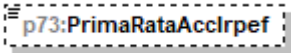
diagram	
type	DatoNP_Type

element **Primo_Modulo_PL_Type/Prospetto/LiquidazioneImposte/SecondaRataAcclrpef**

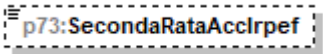
diagram	
type	DatoNP_Type

element **Primo_Modulo_PL_Type/Prospetto/LiquidazioneImposte/AcontoTassSep**

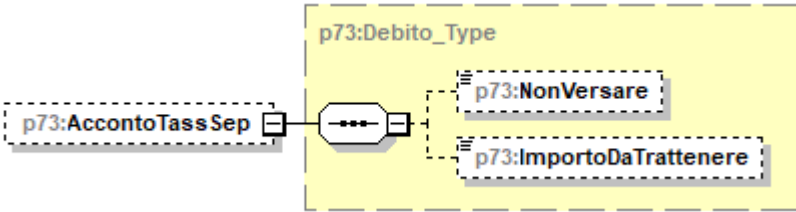
diagram	
type	p73:Debito_Type
children	p73:NonVersare p73:ImportoDaTrattenere

element **Primo_Modulo_PL_Type/Prospetto/LiquidazioneImposte/AcontoAddComunale**

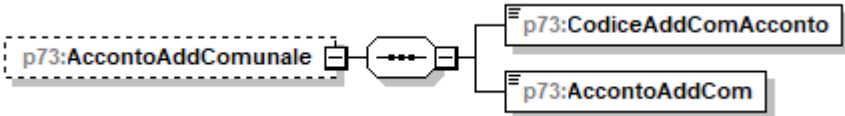
diagram	
children	p73:CodiceAddComAcconto p73:AccontoAddCom

element

Primo_Modulo_PL_Type/Prospetto/LiquidazioneImposte/AcontoAddComunale/CodiceAddComAcconto

diagram	
type	DatoAN_Type

element

Primo_Modulo_PL_Type/Prospetto/LiquidazioneImposte/AcontoAddComunale/AcontoAddCom

diagram	
type	DatoNP_Type

element **Primo_Modulo_PL_Type/Prospetto/LiquidazioneImposte/ImpostaSostitutiva**

diagram	
type	p73:Debito_Type
children	p73:NonVersare p73:ImportoDaTrattenere

element **Primo_Modulo_PL_Type/Prospetto/LiquidazioneImposte/EsitoCedolareSecca**

diagram	
type	p73:Esito_Liquidazione_Type
children	p73:Credito p73:Debito

element **Primo_Modulo_PL_Type/Prospetto/LiquidazioneImposte/PrimaRataAccCedolare**

diagram	
type	DatoNP_Type

element **Primo_Modulo_PL_Type/Prospetto/LiquidazioneImposte/SecondaRataAccCedolare**

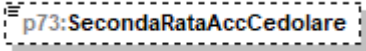
<p>diagram</p>	
<p>type</p>	<p>DatoNP_Type</p>

element **Primo_Modulo_PL_Type/Prospetto/AltriDati**

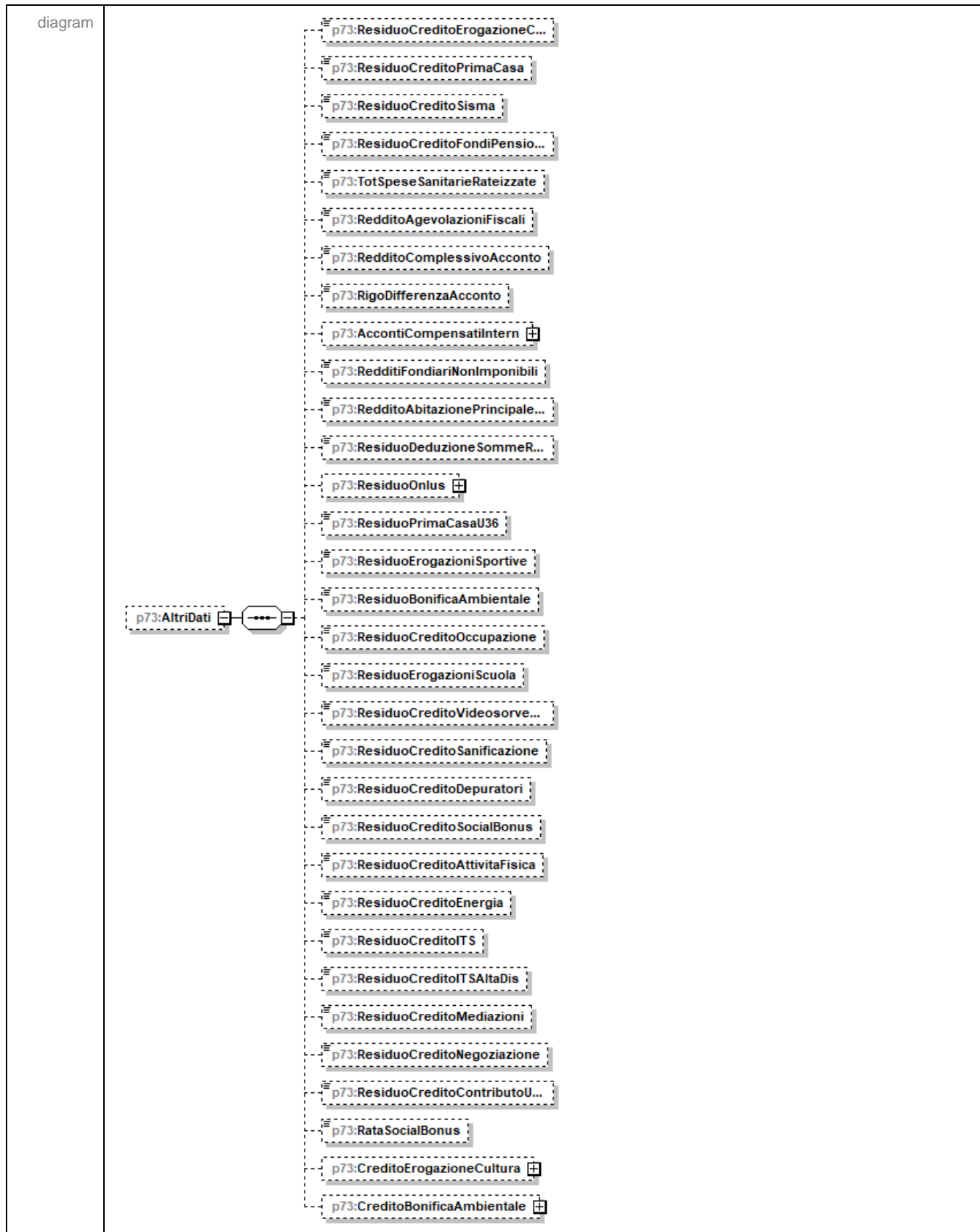

type	extension of p73:Altri_Dati_Type
children	p73:ResiduoCreditoErogazioneCultura p73:ResiduoCreditoPrimaCasa p73:ResiduoCreditoSisma p73:ResiduoCreditoFondiPensione p73:TotSpeseSanitarieRateizzate p73:RedditoAgevolazioniFiscali p73:RedditoComplessivoAcconto p73:RigoDifferenzaAcconto p73:AccontiCompensatiIntern p73:RedditiFondariNonImponibili p73:RedditoAbitazionePrincipalePertinenze p73:ResiduoDeduzioneSommeRestituite p73:ResiduoOnlus p73:ResiduoPrimaCasaU36 p73:ResiduoErogazioniSportive p73:ResiduoBonificaAmbientale p73:ResiduoCreditoOccupazione p73:ResiduoErogazioniScuola p73:ResiduoCreditoVideosorveglianza p73:ResiduoCreditoSanificazione p73:ResiduoCreditoDepuratori p73:ResiduoCreditoSocialBonus p73:ResiduoCreditoAttivitaFisica p73:ResiduoCreditoEnergia p73:ResiduoCreditoITS p73:ResiduoCreditoITSAItaDis p73:ResiduoCreditoMediazioni p73:ResiduoCreditoNegoziazione p73:ResiduoCreditoContributoUnif p73:RataSocialBonus p73:CreditoErogazioneCultura p73:CreditoBonificaAmbientale

element **Primo_Modulo_PL_Type/Prospetto/AltriDati/ResiduoCreditoErogazioneCultura**

diagram	
type	DatoNP_Type

element **Primo_Modulo_PL_Type/Prospetto/AltriDati/ResiduoCreditoPrimaCasa**

diagram	
type	DatoNP_Type

element **Primo_Modulo_PL_Type/Prospetto/AltriDati/ResiduoCreditoSisma**

diagram	
type	DatoNP_Type

element **Primo_Modulo_PL_Type/Prospetto/AltriDati/ResiduoCreditoFondiPensione**

diagram	
type	DatoNP_Type

element **Primo_Modulo_PL_Type/Prospetto/AltriDati/TotSpeseSanitarieRateizzate**

diagram	
type	DatoNP_Type

element **Primo_Modulo_PL_Type/Prospetto/AltriDati/RedditoAgevolazioniFiscali**

diagram	
type	DatoNP_Type

element **Primo_Modulo_PL_Type/Prospetto/AltriDati/RedditoComplessivoAcconto**

diagram	
type	DatoNP_Type

element **Primo_Modulo_PL_Type/Prospetto/AltriDati/RigoDifferenzaAcconto**

diagram	
type	DatoNU_Type

element **Primo_Modulo_PL_Type/Prospetto/AltriDati/AccontiCompensatiIntern**

diagram	
type	p73:Acoonti_Compensati_Intern_Type
children	p73:PrimaRatalrpef p73:AddizionaleComunale p73:PrimaRataCedolare

element **Primo_Modulo_PL_Type/Prospetto/AltriDati/RedditiFondiariNonImponibili**

diagram	
type	DatoNP_Type

element **Primo_Modulo_PL_Type/Prospetto/AltriDati/RedditoAbitazionePrincipalePertinenze**

diagram	
type	DatoNP_Type

element **Primo_Modulo_PL_Type/Prospetto/AltriDati/ResiduoDeduzioneSommeRestituite**

diagram	
type	DatoNP_Type

element **Primo_Modulo_PL_Type/Prospetto/AltriDati/ResiduoOnlus**

diagram	
type	p73:Residuo_Onlus_Type
children	p73:ResiduoTreAnniPrec p73:ResiduoDueAnniPrec p73:ResiduoAnnoPrec p73:ResiduoAnno

element **Primo_Modulo_PL_Type/Prospetto/AltriDati/ResiduoPrimaCasaU36**

diagram	
type	DatoNP_Type

element **Primo_Modulo_PL_Type/Prospetto/AltriDati/ResiduoErogazioniSportive**

diagram	
type	DatoNP_Type

element **Primo_Modulo_PL_Type/Prospetto/AltriDati/ResiduoBonificaAmbientale**

diagram	
type	DatoNP_Type

element **Primo_Modulo_PL_Type/Prospetto/AltriDati/ResiduoCreditoOccupazione**

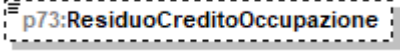
diagram	
type	DatoNP_Type

element **Primo_Modulo_PL_Type/Prospetto/AltriDati/ResiduoErogazioniScuola**

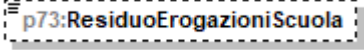
diagram	
type	DatoNP_Type

element **Primo_Modulo_PL_Type/Prospetto/AltriDati/ResiduoCreditoVideosorveglianza**

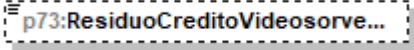
diagram	
type	DatoNP_Type

element **Primo_Modulo_PL_Type/Prospetto/AltriDati/ResiduoCreditoSanificazione**

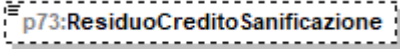
diagram	
type	DatoNP_Type

element **Primo_Modulo_PL_Type/Prospetto/AltriDati/ResiduoCreditoDepuratori**

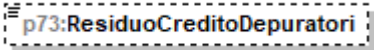
diagram	
type	DatoNP_Type

element **Primo_Modulo_PL_Type/Prospetto/AltriDati/ResiduoCreditoSocialBonus**

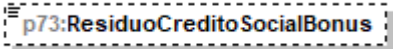
diagram	
type	DatoNP_Type

element **Primo_Modulo_PL_Type/Prospetto/AltriDati/ResiduoCreditoAttivitaFisica**

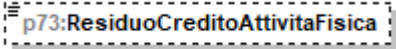
diagram	
type	DatoNP_Type

element **Primo_Modulo_PL_Type/Prospetto/AltriDati/ResiduoCreditoEnergia**

diagram	
type	DatoNP_Type

element **Primo_Modulo_PL_Type/Prospetto/AltriDati/ResiduoCreditoITS**

diagram	
type	DatoNP_Type

element **Primo_Modulo_PL_Type/Prospetto/AltriDati/ResiduoCreditoITSAItaDis**

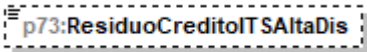
diagram	
type	DatoNP_Type

element **Primo_Modulo_PL_Type/Prospetto/AltriDati/ResiduoCreditoMediazioni**

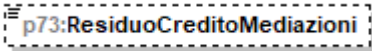
diagram	
type	DatoNP_Type

element **Primo_Modulo_PL_Type/Prospetto/AltriDati/ResiduoCreditoNegoziazione**

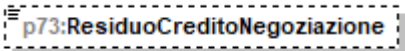
diagram	
type	DatoNP_Type

element **Primo_Modulo_PL_Type/Prospetto/AltriDati/ResiduoCreditoContributoUnif**

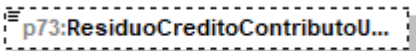
diagram	
type	DatoNP_Type

element **Primo_Modulo_PL_Type/Prospetto/AltriDati/RataSocialBonus**

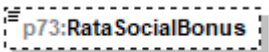
diagram	
type	DatoNP_Type

element **Primo Modulo_PL_Type/Prospetto/AltriDati/CreditoErogazioneCultura**

diagram	
type	p73:Cred_Erogazione_Cultura_Type
children	p73:RataAnnoPrec p73:RataAnno

element **Primo Modulo_PL_Type/Prospetto/AltriDati/CreditoBonificaAmbientale**

diagram	
type	p73:Cred_Erogazione_Cultura_Type
children	p73:RataAnnoPrec p73:RataAnno

element **Primo Modulo_PL_Type/Prospetto/CredImpEstero**

diagram	
type	p73:Cred_Imp_Estero_Type
children	p73:Anno p73:TotCredito p73:CreditoStato

element **Primo_Modulo_PL_Type/Prospetto/DatiCreditiF24**

<p>diagram</p>	
<p>type</p>	<p>p73:Crediti_F24_Type</p>
<p>children</p>	<p>p73:Credlrpef p73:CredlrpefDipNoSostituto p73:CodAddReg p73:CredAddReg p73:CredAddRegDipNoSostituto p73:CodiceAddCom p73:CredAddCom p73:CredAddComDipNoSostituto p73:CredCedolare p73:CredCedolareDipNoSostituto p73:CredTassSeparDipNoSostituto p73:CredImpostaSostDipNoSostituto p73:DatiF24Cripto p73:DatiF24lvie p73:DatiF24lvafe p73:DatiF24FonteEstera p73:DatiF24Mance p73:TotaleCredito p73:TotaleDipNoSostituto p73:TotaleDebito</p>

element **Primo Modulo_PL_Type/Prospetto/LiquidazioneImposteSost**

<p>diagram</p>	
<p>children</p>	<p>p73:EsitoCripto p73:PrimaRataAccCripto p73:SecondaRataAccCripto p73:Esitolvie p73:PrimaRataAcclvie p73:SecondaRataAcclvie p73:Esitolvafe p73:PrimaRataAcclvafe p73:SecondaRataAcclvafe p73:EsitoCapitaleFonteEstera p73:EsitoMance</p>

element **Primo Modulo_PL_Type/Prospetto/LiquidazioneImposteSost/EsitoCripto**

<p>diagram</p>	
<p>children</p>	<p>p73:ImpostaDovuta p73:ImpostaDebito p73:EccedenzaVers p73:CreditoComp p73:Rimborso</p>

element **Primo Modulo_PL_Type/Prospetto/LiquidazioneImposteSost/EsitoCripto/ImpostaDovuta**

<p>diagram</p>	
----------------	--

type	DatoNP_Type
------	-----------------------------

element **Primo_Modulo_PL_Type/Prospetto/LiquidazioneImposteSost/EsitoCripto/ImpostaDebito**

diagram	
type	DatoNP_Type

element **Primo_Modulo_PL_Type/Prospetto/LiquidazioneImposteSost/EsitoCripto/EccedenzaVers**

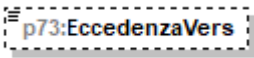
diagram	
type	DatoNP_Type

element **Primo_Modulo_PL_Type/Prospetto/LiquidazioneImposteSost/EsitoCripto/CreditoComp**

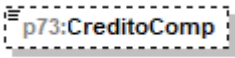
diagram	
type	DatoNP_Type

element **Primo_Modulo_PL_Type/Prospetto/LiquidazioneImposteSost/EsitoCripto/Rimborso**

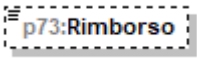
diagram	
type	DatoNP_Type

element **Primo_Modulo_PL_Type/Prospetto/LiquidazioneImposteSost/PrimaRataAccCripto**

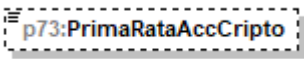
diagram	
type	DatoNP_Type

element **Primo_Modulo_PL_Type/Prospetto/LiquidazioneImposteSost/SecondaRataAccCripto**

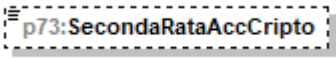
diagram	
type	DatoNP_Type

element **Primo_Modulo_PL_Type/Prospetto/LiquidazioneImposteSost/Esitolvie**

<p>diagram</p>	
<p>type</p>	<p>p73:Esito_Sost_Type</p>
<p>children</p>	<p>p73:ImpostaDovuta p73:EccedenzaPrecDic p73:AccontiVersati p73:ImpostaDebito p73:ImpostaCredito p73:EccedenzaVers p73:CreditoComp p73:Rimborso</p>

element **Primo_Modulo_PL_Type/Prospetto/LiquidazioneImposteSost/PrimaRataAcclvie**

<p>diagram</p>	
<p>type</p>	<p>DatoNP_Type</p>

element **Primo_Modulo_PL_Type/Prospetto/LiquidazioneImposteSost/SecondaRataAcclvie**

<p>diagram</p>	
<p>type</p>	<p>DatoNP_Type</p>

element **Primo_Modulo_PL_Type/Prospetto/LiquidazioneImposteSost/Esitolvafe**

<p>diagram</p>	
<p>type</p>	<p>p73:Esito_Sost_Type</p>
<p>children</p>	<p>p73:ImpostaDovuta p73:EccedenzaPrecDic p73:AccontiVersati p73:ImpostaDebito p73:ImpostaCredito p73:EccedenzaVers p73:CreditoComp p73:Rimborso</p>

element **Primo_Modulo_PL_Type/Prospetto/LiquidazioneImposteSost/PrimaRataAcclvafe**

<p>diagram</p>	
<p>type</p>	<p>DatoNP_Type</p>

element **Primo_Modulo_PL_Type/Prospetto/LiquidazioneImposteSost/SecondaRataAcclvafe**

<p>diagram</p>	
<p>type</p>	<p>DatoNP_Type</p>

element **Primo_Modulo_PL_Type/Prospetto/LiquidazioneImposteSost/EsitoCapitaleFonteEster**

<p>diagram</p>	
----------------	--

children	p73:ImpostaDebito p73:EccedenzaVers p73:CreditoComp p73:Rimborso
----------	--

element

Primo_Modulo_PL_Type/Prospetto/LiquidazioneImposteSost/EsitoCapitaleFonteEstera/ImpostaDebito

diagram	
type	DatoNP_Type

element

Primo_Modulo_PL_Type/Prospetto/LiquidazioneImposteSost/EsitoCapitaleFonteEstera/EccedenzaVers

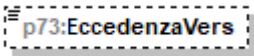
diagram	
type	DatoNP_Type

element

Primo_Modulo_PL_Type/Prospetto/LiquidazioneImposteSost/EsitoCapitaleFonteEstera/CreditoComp

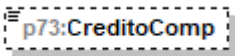
diagram	
type	DatoNP_Type

element

Primo_Modulo_PL_Type/Prospetto/LiquidazioneImposteSost/EsitoCapitaleFonteEstera/Rimborso

diagram	
type	DatoNP_Type

element **Primo_Modulo_PL_Type/Prospetto/LiquidazioneImposteSost/EsitoMance**

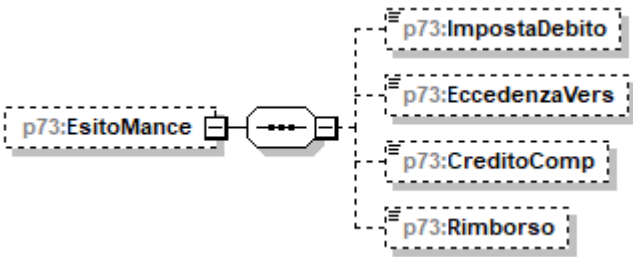
diagram	
children	p73:ImpostaDebito p73:EccedenzaVers p73:CreditoComp p73:Rimborso

element **Primo_Modulo_PL_Type/Prospetto/LiquidazioneImposteSost/EsitoMance/ImpostaDebito**

diagram	
type	DatoNP_Type

element **Primo_Modulo_PL_Type/Prospetto/LiquidazioneImposteSost/EsitoMance/EccedenzaVers**

diagram	
type	DatoNP_Type

element **Primo_Modulo_PL_Type/Prospetto/LiquidazioneImposteSost/EsitoMance/CreditoComp**

diagram	
type	DatoNP_Type

element **Primo_Modulo_PL_Type/Prospetto/LiquidazioneImposteSost/EsitoMance/Rimborso**

diagram	
type	DatoNP_Type

element **Primo_Modulo_PL_Type/ProspettoRideterminato**

diagram	
type	extension of p73:Prospetto_Type
children	p73:RiepilogoRedditi p73:ImpostaLorda p73:DetrazioniCrediti p73:ImpostaNetta p73:RedditoAgevolazioniFiscali

element **Primo_Modulo_PL_Type/ProspettoRideterminato/RedditoAgevolazioniFiscali**

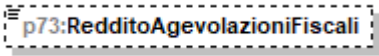
diagram	
type	DatoNP_Type

complexType **Prospetto_Liquidazione_Type**

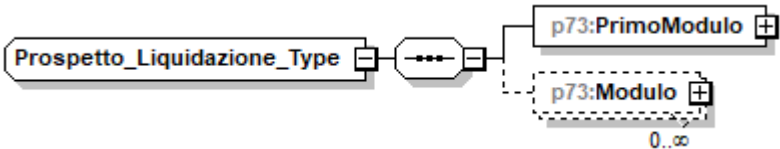
diagram	
children	p73:PrimoModulo p73:Modulo

element **Prospetto_Liquidazione_Type/PrimoModulo**

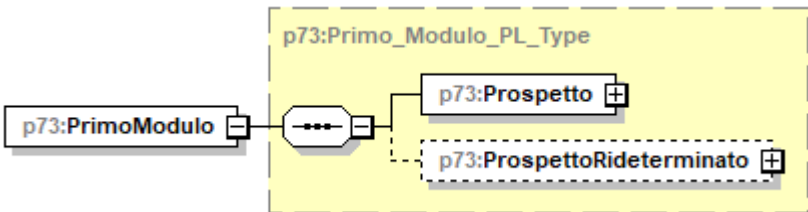
diagram	
type	p73:Primo_Modulo_PL_Type
children	p73:Prospetto p73:ProspettoRideterminato

element **Prospetto_Liquidazione_Type/Modulo**

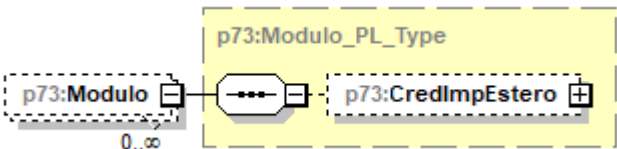
diagram	
type	p73:Modulo_PL_Type
children	p73:CredImpEstero

complexType **Prospetto_Type**

<p>diagram</p>	
<p>children</p>	<p>p73:RiepilogoRedditi p73:ImpostaLorda p73:DetrazioniCrediti p73:ImpostaNetta</p>

element **Prospetto_Type/RiepilogoRedditi**

<p>diagram</p>	
<p>type</p>	<p>p73:Riepilogo_Redditi_Type</p>
<p>children</p>	<p>p73:Dominicali p73:Agrari p73:Fabbricati p73:LavDip p73:AltriRedditi p73:ImponibileCedolare p73:ImponibileCedolareOrdinario p73:ImponibileCedolareAgevolato p73:AbitazionePrincipalePertinenze p73:CapitaleFonteEstera</p>

element **Prospetto_Type/ImpostaLorda**

<p>diagram</p>	<pre> classDiagram class p73ImpostaLorda class p73Imposta_Lorda_Type { p73RedditoComplessivo p73DeduzioneAbitazPrincipale p73OneriDeducibili p73RedditoImponibile p73CompensiAttSport p73ImportoImpostaLorda } p73ImpostaLorda o-- p73Imposta_Lorda_Type </pre>
<p>type</p>	<p>p73:Imposta_Lorda_Type</p>
<p>children</p>	<p>p73:RedditoComplessivo p73:DeduzioneAbitazPrincipale p73:OneriDeducibili p73:RedditoImponibile p73:CompensiAttSport p73:ImportoImpostaLorda</p>

element **Prospetto_Type/DetrazioniCrediti**

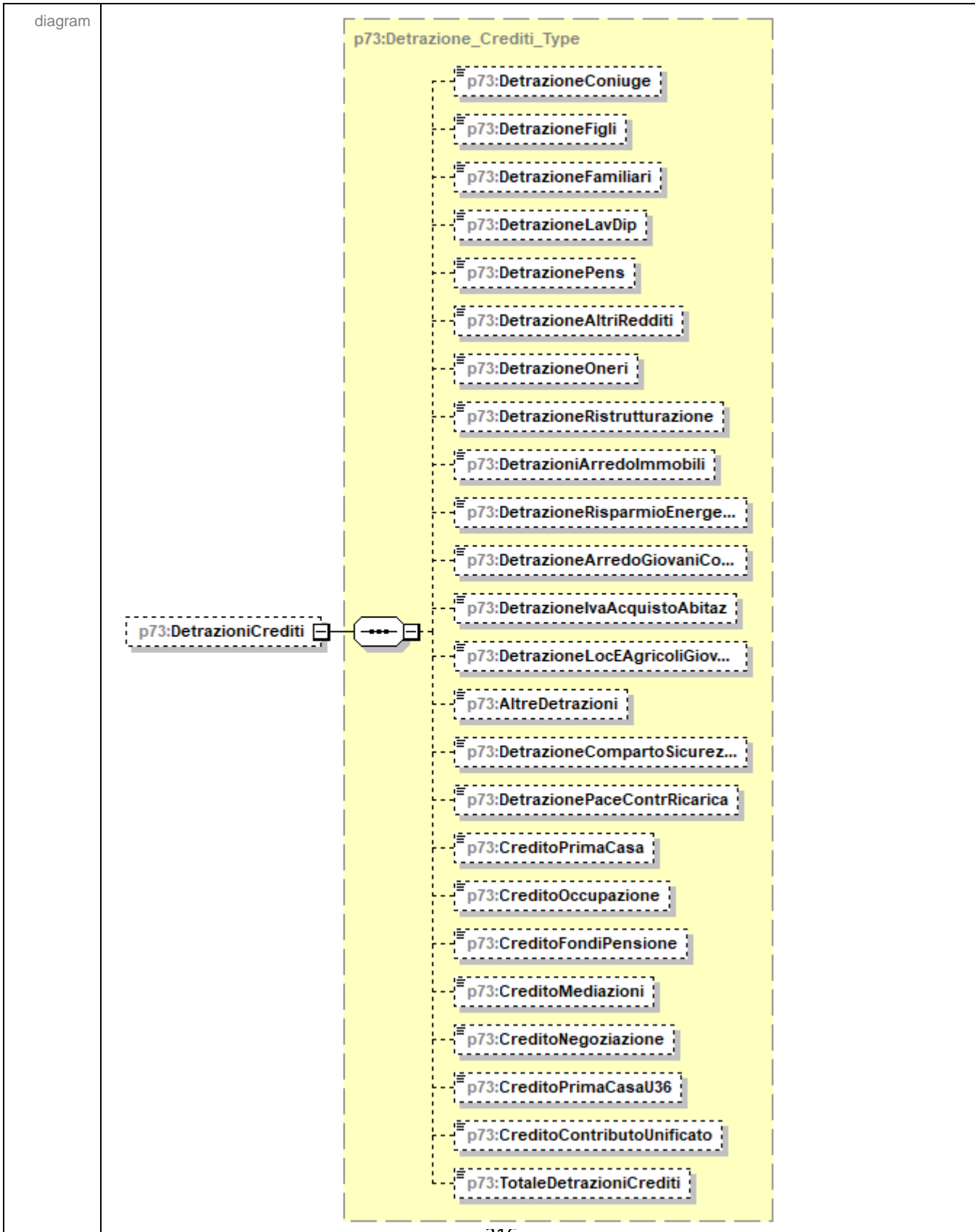

type	p73:Detrazione_Crediti_Type
children	p73:DetrazioneConiuge p73:DetrazioneFigli p73:DetrazioneFamiliari p73:DetrazioneLavDip p73:DetrazionePens p73:DetrazioneAltriRedditi p73:DetrazioneOneri p73:DetrazioneRistrutturazione p73:DetrazioniArredolmmobili p73:DetrazioneRisparmioEnergetico p73:DetrazioneArredoGiovaniCoppie p73:DetrazioneIvaAcquistoAbitaz p73:DetrazioneLocEAgricoliGiovani p73:AltreDetrazioni p73:DetrazioneCompartoSicurezza p73:DetrazionePaceContrRicarica p73:CreditoPrimaCasa p73:CreditoOccupazione p73:CreditoFondiPensione p73:CreditoMediazioni p73:CreditoNegoziazione p73:CreditoPrimaCasaU36 p73:CreditoContributoUnificato p73:TotaleDetrazioniCrediti

element **Prospetto_Type/ImpostaNetta**

diagram	
type	p73:Imposta_Netta_Type
children	p73:ImportoImpostaNetta p73:CredAltriSisma p73:CredAbitazSisma p73:CredImpEstere p73:CredErogCultura

p73:CredErogScuola p73:CredVideosorveglianza p73:AltriCrediti p73:CredDetrazIncapienti p73:Ritenute p73:Differenza p73:EccedenzaIrpref p73:AccontiVersati p73:CredRimborsatiSost p73:TrattamentoIntSpettante p73:TrattamentoIntRiconosciuto p73:RestituzioneTrattamentoInt
--

complexType **Redditi_Capitale_Sost_Type**

diagram
children p73:Tipo p73:CodiceStatoEstero p73:AmmontareReddito p73:Aliquota p73:Creditolvca p73:OpzioneOrdinaria p73:ProventiParticolari p73:EccedenzaVersamento

element **Redditi_Capitale_Sost_Type/Tipo**

diagram
type DatoAN_Type

element **Redditi_Capitale_Sost_Type/CodiceStatoEstero**

diagram
type DatoAN_Type

element **Redditi_Capitale_Sost_Type/AmmontareReddito**

diagram
type DatoNP_Type

element **Redditi_Capitale_Sost_Type/Aliquota**

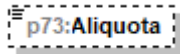
diagram	
type	DatoPC_Type

element **Redditi_Capitale_Sost_Type/Creditolva**

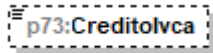
diagram	
type	DatoNP_Type

element **Redditi_Capitale_Sost_Type/OpzioneOrdinaria**

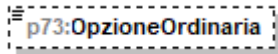
diagram	
type	DatoCB_Type

element **Redditi_Capitale_Sost_Type/ProventiParticolari**

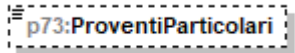
diagram	
type	DatoCB_Type

element **Redditi_Capitale_Sost_Type/EccedenzaVersamento**

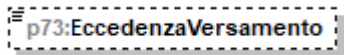
diagram	
type	DatoNP_Type

complexType **Redditi_Capitale_Type**

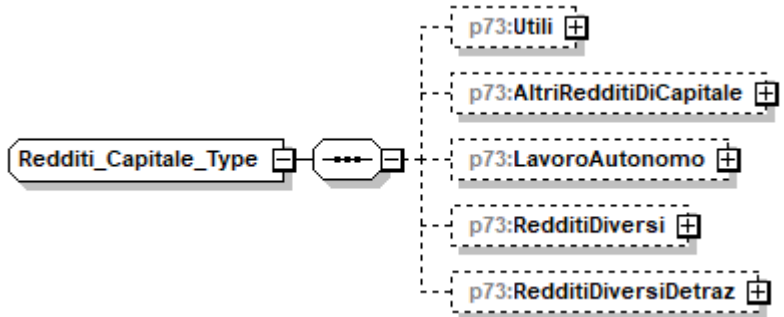
diagram	
children	p73:Utili p73:AltriRedditiDiCapitale p73:LavoroAutonomo p73:RedditiDiversi p73:RedditiDiversiDetraz

element **Redditi_Capitale_Type/Utili**

diagram	<p>The diagram illustrates the structure of the p73:Altri_Redditi_Utili_Type element. It is composed of a p73:Utili element (dashed box) connected to a container element (hexagon with a dashed border). This container element contains two sub-elements: p73:Tipo_Reddito (solid box) and p73:RedditiRitenute (dashed box with a plus sign).</p>
type	p73:Altri_Redditi_Utili_Type
children	p73:Tipo_Reddito p73:RedditiRitenute

element **Redditi_Capitale_Type/AltriRedditiDiCapitale**

diagram	<p>The diagram illustrates the structure of the p73:Sezione_Altri_Redd_Type element. It is composed of a p73:AltriRedditiDiCapitale element (dashed box) connected to a container element (hexagon with a dashed border). This container element contains two sub-elements: p73:TipoReddito (dashed box) and p73:RedditiRitenute (dashed box with a plus sign).</p>
type	p73:Sezione_Altri_Redd_Type
children	p73:TipoReddito p73:RedditiRitenute

element **Redditi_Capitale_Type/LavoroAutonomo**

diagram	<p>The diagram illustrates the structure of the p73:Altri_Redditi_Lavoro_Autonomo_Type element. It is composed of a p73:LavoroAutonomo element (dashed box) connected to a container element (hexagon with a dashed border). This container element contains three sub-elements: p73:AltriDati (dashed box), p73:TipoReddito (dashed box), and p73:RedditiRitenute (dashed box with a plus sign).</p>
type	p73:Altri_Redditi_Lavoro_Autonomo_Type
children	p73:AltriDati p73:TipoReddito p73:RedditiRitenute

element **Redditi_Capitale_Type/RedditiDiversi**

diagram	
type	p73:Altri Redditi Diversi Type
children	p73:CedolareSecca p73:TipoReddito p73:RedditiRitenuteSpese

element **Redditi_Capitale_Type/RedditiDiversiDetraz**

diagram	
type	p73:Altri Redditi Diversi Detr Type
children	p73:AltriDati p73:Tipo_Reddito p73:RedditiRitenuteSpese

complexType **Redditi_Eredi_Legatari_Type**

diagram	
type	extension of p73:Tassazione Separata Type
children	p73:Opzione p73:Anno p73:RedditoRitenute p73:TipoReddito p73:RedditoTotale p73:QuotalImposteSuccessioni

element **Redditi_Eredi_Legatari_Type/TipoReddito**

diagram																																	
type	restriction of DatoNP_Type																																
facets	<table border="1"> <thead> <tr> <th>Kind</th> <th>Value</th> </tr> </thead> <tbody> <tr><td>enumeration</td><td>1</td></tr> <tr><td>enumeration</td><td>2</td></tr> <tr><td>enumeration</td><td>3</td></tr> <tr><td>enumeration</td><td>4</td></tr> <tr><td>enumeration</td><td>5</td></tr> <tr><td>enumeration</td><td>6</td></tr> <tr><td>enumeration</td><td>7</td></tr> <tr><td>enumeration</td><td>8</td></tr> <tr><td>enumeration</td><td>9</td></tr> <tr><td>enumeration</td><td>10</td></tr> <tr><td>enumeration</td><td>11</td></tr> <tr><td>enumeration</td><td>12</td></tr> <tr><td>enumeration</td><td>13</td></tr> <tr><td>enumeration</td><td>14</td></tr> <tr><td>enumeration</td><td>15</td></tr> </tbody> </table>	Kind	Value	enumeration	1	enumeration	2	enumeration	3	enumeration	4	enumeration	5	enumeration	6	enumeration	7	enumeration	8	enumeration	9	enumeration	10	enumeration	11	enumeration	12	enumeration	13	enumeration	14	enumeration	15
Kind	Value																																
enumeration	1																																
enumeration	2																																
enumeration	3																																
enumeration	4																																
enumeration	5																																
enumeration	6																																
enumeration	7																																
enumeration	8																																
enumeration	9																																
enumeration	10																																
enumeration	11																																
enumeration	12																																
enumeration	13																																
enumeration	14																																
enumeration	15																																

element **Redditi_Eredi_Legatari_Type/RedditoTotale**

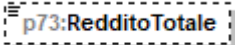
diagram	
type	DatoNP_Type

element **Redditi_Eredi_Legatari_Type/QuotalImposteSuccessioni**

diagram	
type	DatoNP_Type

complexType **Redditi_Fabbricati_Type**

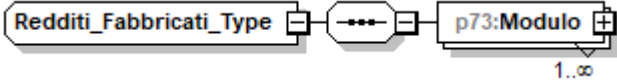
diagram	
children	p73:Modulo

element **Redditi_Fabbricati_Type/Modulo**

<p>diagram</p>	
<p>type</p>	<p>p73:Modulo_Fabbricato_Type</p>
<p>children</p>	<p>p73:FabbricatoOrd p73:FabbricatoAgev</p>

complexType **Redditi_Lavoro_Dip_Type**

<p>diagram</p>	
<p>children</p>	<p>p73:PrimoModulo p73:Modulo</p>

element **Redditi_Lavoro_Dip_Type/PrimoModulo**

<p>diagram</p>	
<p>type</p>	<p>p73:Primo_Modulo_Lavoro_Dip_Type</p>
<p>children</p>	<p>p73:LavoroDipendente p73:PremiRisultato p73:PeriodoLavoro p73:AltriRedditiAssLavDip p73:RitenuteLavoroDipendente p73:RiduzionePressioneFiscale p73:CasellaCasiParticolari p73:StatoEstero p73:CompartoSicurezza p73:Mance</p>

element **Redditi_Lavoro_Dip_Type/Modulo**

<p>diagram</p>	
<p>type</p>	<p>p73:Modulo_Lavoro_Dip_Type</p>

children	p73:LavoroDipendente p73:PremiRisultato p73:AltriRedditiAssLavDip p73:Mance
----------	---

complexType **Redditi_Ritenute_Spese_Type**

diagram	
type	extension of p73:Redditi_Ritenute_Type
children	p73:ImportoRedditi p73:ImportoRitenute p73:ImportoSpese

element **Redditi_Ritenute_Spese_Type/ImportoSpese**

diagram	
type	DatoNP_Type

complexType **Redditi_Ritenute_Type**

diagram	
children	p73:ImportoRedditi p73:ImportoRitenute

element **Redditi_Ritenute_Type/ImportoRedditi**

diagram	
type	DatoNP_Type

element **Redditi_Ritenute_Type/ImportoRitenute**

diagram	
type	DatoNP_Type

complexType **Redditi_Tassazione_Separata_Type**

diagram	
children	<p>p73:RedditiErede p73:ImposteRimborsate</p>

element **Redditi_Tassazione_Separata_Type/RedditiErede**

diagram	
type	<p>p73:Redditi_Eredi_Legatari_Type</p>
children	<p>p73:Opzione p73:Anno p73:RedditoRitenute p73:TipoReddito p73:RedditoTotale p73:QuotalImposteSuccessioni</p>

element **Redditi_Tassazione_Separata_Type/ImposteRimborsate**

diagram	
type	<p>p73:Imposte_Rimborsate_Type</p>
children	<p>p73:TipoReddito p73:TassazioneSeparata</p>

complexType **Redditi_Terreni_Type**

diagram	
---------	--

children	p73:Modulo
----------	----------------------------

element **Redditi_Terreni_Type/Modulo**

diagram	
type	p73:Modulo_Terreno_Type
children	p73:Terreno

complexType **Reddito_Campione_Franchi_Type**

diagram	
children	p73:Codice p73:Importo

element **Reddito_Campione_Franchi_Type/Codice**

diagram													
type	restriction of DatoNP_Type												
facets	<table border="1"> <thead> <tr> <th>Kind</th> <th>Value</th> </tr> </thead> <tbody> <tr> <td>enumeration</td> <td>1</td> </tr> <tr> <td>enumeration</td> <td>2</td> </tr> <tr> <td>enumeration</td> <td>3</td> </tr> <tr> <td>enumeration</td> <td>4</td> </tr> <tr> <td>enumeration</td> <td>5</td> </tr> </tbody> </table>	Kind	Value	enumeration	1	enumeration	2	enumeration	3	enumeration	4	enumeration	5
Kind	Value												
enumeration	1												
enumeration	2												
enumeration	3												
enumeration	4												
enumeration	5												

element **Reddito_Campione_Franchi_Type/Importo**

diagram	
type	DatoNP_Type

complexType **Reddito_Campione_Type**

diagram	
---------	--

children	p73:Codice p73:Importo
----------	--

element **Reddito_Campione_Type/Codice**

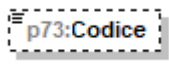
diagram											
type	restriction of DatoNP_Type										
facets	<table border="1"> <thead> <tr> <th>Kind</th> <th>Value</th> </tr> </thead> <tbody> <tr> <td>enumeration</td> <td>1</td> </tr> <tr> <td>enumeration</td> <td>2</td> </tr> <tr> <td>enumeration</td> <td>3</td> </tr> <tr> <td>enumeration</td> <td>6</td> </tr> </tbody> </table>	Kind	Value	enumeration	1	enumeration	2	enumeration	3	enumeration	6
Kind	Value										
enumeration	1										
enumeration	2										
enumeration	3										
enumeration	6										

element **Reddito_Campione_Type/Importo**

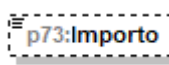
diagram	
type	DatoNP_Type

complexType **Reddito_Erede_Type**

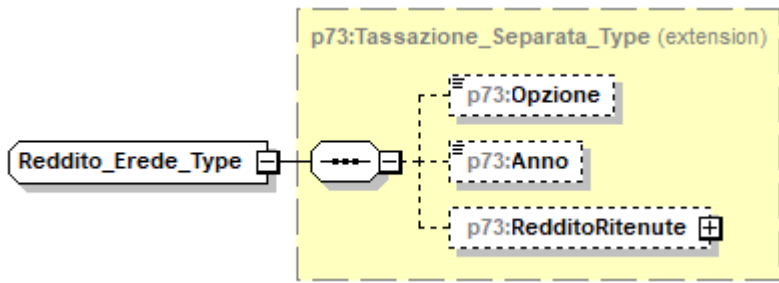
diagram	
type	extension of p73:Tassazione Separata_Type
children	p73:Opzione p73:Anno p73:RedditoRitenute

complexType **Residuo_Credito_Compens_AnnolImposta_Type**

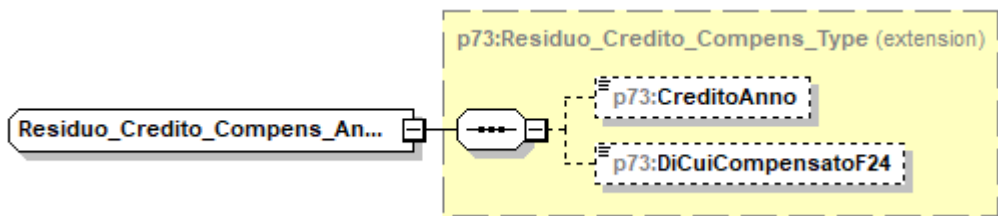
diagram	
type	extension of p73:Residuo Credito Compens_Type
children	p73:CreditoAnno p73:DiCuiCompensatoF24

complexType **Residuo_Credito_Compens_Type**

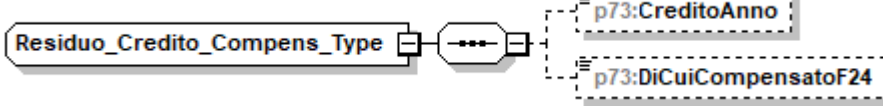
diagram	
children	p73:CreditoAnno p73:DiCuiCompensatoF24

element **Residuo_Credito_Compens_Type/CreditoAnno**

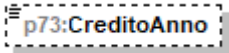
diagram	
type	DatoNP_Type

element **Residuo_Credito_Compens_Type/DiCuiCompensatoF24**

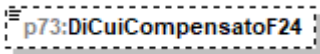
diagram	
type	DatoNP_Type

complexType **Residuo_Fabbricati_Type**

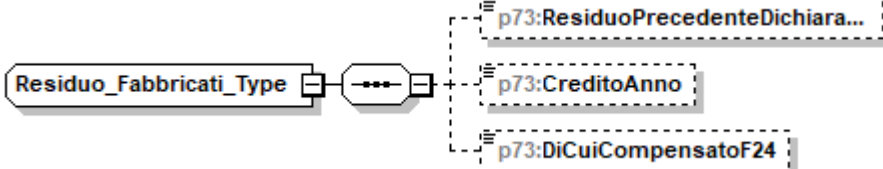
diagram	
children	p73:ResiduoPrecedenteDichiarazione p73:CreditoAnno p73:DiCuiCompensatoF24

element **Residuo_Fabbricati_Type/ResiduoPrecedenteDichiarazione**

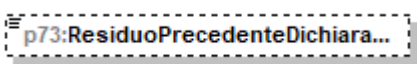
diagram	
type	DatoNP_Type

element **Residuo_Fabbricati_Type/CreditoAnno**

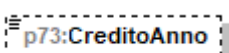
diagram	
type	DatoNP_Type

element **Residuo_Fabbricati_Type/DiCuiCompensatoF24**

diagram	
type	DatoNP_Type

complexType **Residuo_Onlus_Type**

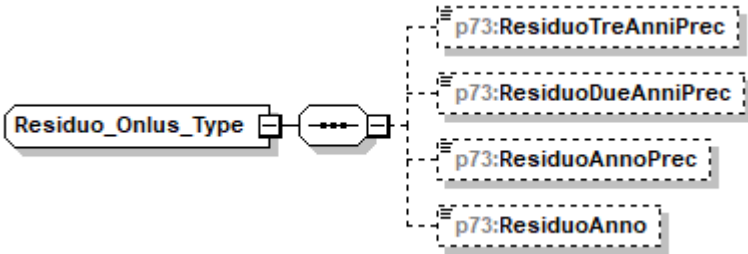
diagram	
children	p73:ResiduoTreAnniPrec p73:ResiduoDueAnniPrec p73:ResiduoAnnoPrec p73:ResiduoAnno

element **Residuo_Onlus_Type/ResiduoTreAnniPrec**

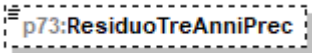
diagram	
type	DatoNP_Type

element **Residuo_Onlus_Type/ResiduoDueAnniPrec**

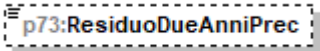
diagram	
type	DatoNP_Type

element **Residuo_Onlus_Type/ResiduoAnnoPrec**

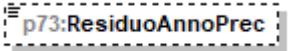
diagram	
type	DatoNP_Type

element **Residuo_Onlus_Type/ResiduoAnno**

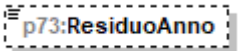
diagram	
type	DatoNP_Type

complexType Restituzione_Somme_Type

diagram	
children	p73:SommeRestituite p73:ResiduoPrecedenteDic

element Restituzione_Somme_Type/SommeRestituite

diagram	
type	DatoNP_Type

element Restituzione_Somme_Type/ResiduoPrecedenteDic

diagram	
type	DatoNP_Type

complexType Riduzione_Pressione_Type

diagram	
children	p73:CodiceTrattamento p73:TrattamentoErogato p73:EsenzioneRicercatori p73:EsenzioneImpatriati

element Riduzione_Pressione_Type/CodiceTrattamento

diagram							
type	restriction of DatoN1_Type						
facets	<table border="1"> <thead> <tr> <th>Kind</th> <th>Value</th> </tr> </thead> <tbody> <tr> <td>enumeration</td> <td>1</td> </tr> <tr> <td>enumeration</td> <td>2</td> </tr> </tbody> </table>	Kind	Value	enumeration	1	enumeration	2
Kind	Value						
enumeration	1						
enumeration	2						

element **Riduzione_Pressione_Type/TrattamentoErogato**

diagram	
type	DatoNP_Type

element **Riduzione_Pressione_Type/EsenzioneRicercatori**

diagram	
type	DatoNP_Type

element **Riduzione_Pressione_Type/EsenzioneImpatriati**

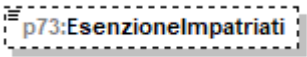
diagram	
type	DatoNP_Type

complexType **Riepilogo_Redditi_Type**

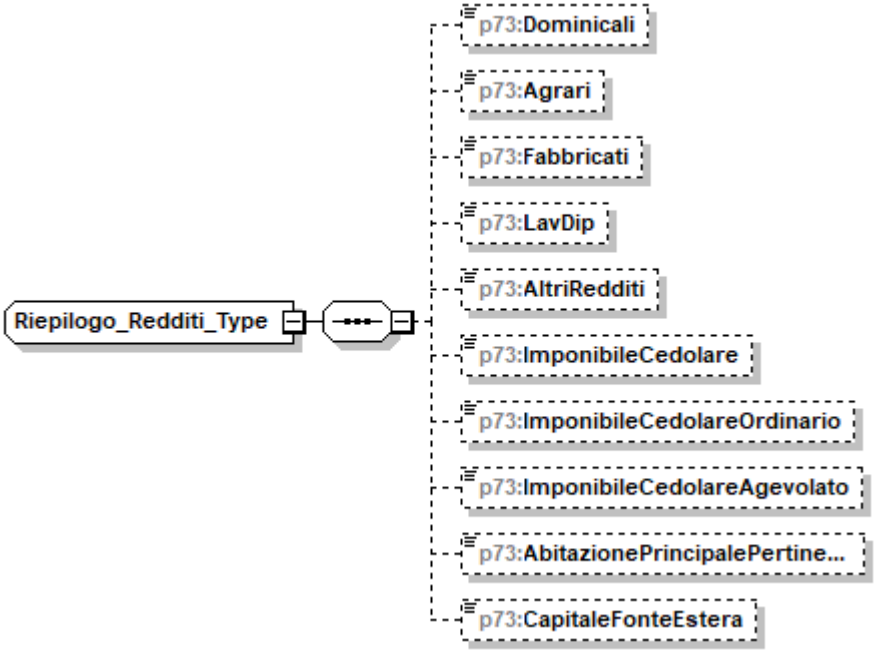
diagram	
children	p73:Dominicali p73:Agrari p73:Fabbricati p73:LavDip p73:AltriRedditi p73:ImponibileCedolare p73:ImponibileCedolareOrdinario p73:ImponibileCedolareAgevolato p73:AbitazionePrincipalePertinenze p73:CapitaleFonteEstera

element **Riepilogo_Reddito_Type/Dominicali**

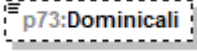
diagram	
type	DatoNP_Type

element **Riepilogo_Reddito_Type/Agrari**

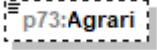
diagram	
type	DatoNP_Type

element **Riepilogo_Reddito_Type/Fabbricati**

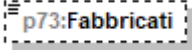
diagram	
type	DatoNP_Type

element **Riepilogo_Reddito_Type/LavDip**

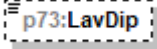
diagram	
type	DatoNP_Type

element **Riepilogo_Reddito_Type/AltriRedditi**

diagram	
type	DatoNP_Type

element **Riepilogo_Reddito_Type/ImponibileCedolare**

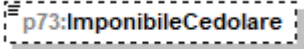
diagram	
type	DatoNP_Type

element **Riepilogo_Reddito_Type/ImponibileCedolareOrdinario**

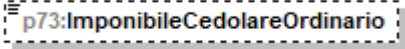
diagram	
type	DatoNP_Type

element **Riepilogo_Reddito_Type/ImponibileCedolareAgevolato**

diagram	
type	DatoNP_Type

element **Riepilogo_Reddito_Type/AbitazionePrincipalePertinenze**

diagram	
type	DatoNP_Type

element **Riepilogo_Reddito_Type/CapitaleFonteEstera**

diagram	
type	DatoNP_Type

complexType **Ritenute_Acconti_Sospesi_Type**

diagram	
children	p73:CodiceEvento p73:lrpef p73:AddRegionalelrpef p73:AddComunalelrpef p73:SostitutivaPremi p73:CedolareSecca p73:SostitutivaRita

element **Ritenute_Acconti_Sospesi_Type/CodiceEvento**

diagram							
type	p73:Codice_Evento_Eccezionale_Type						
facets	<table border="1"> <thead> <tr> <th>Kind</th> <th>Value</th> </tr> </thead> <tbody> <tr> <td>enumeration</td> <td>1</td> </tr> <tr> <td>enumeration</td> <td>2</td> </tr> </tbody> </table>	Kind	Value	enumeration	1	enumeration	2
Kind	Value						
enumeration	1						
enumeration	2						

	enumeration 3 enumeration 99
--	---------------------------------

element Ritenute_Acconti_Sospesi_Type/Irpef

diagram	
type	DatoNP_Type

element Ritenute_Acconti_Sospesi_Type/AddRegionaleIrpef

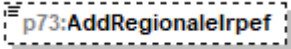
diagram	
type	DatoNP_Type

element Ritenute_Acconti_Sospesi_Type/AddComunaleIrpef

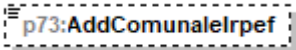
diagram	
type	DatoNP_Type

element Ritenute_Acconti_Sospesi_Type/SostitutivaPremi

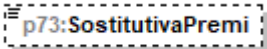
diagram	
type	DatoNP_Type

element Ritenute_Acconti_Sospesi_Type/CedolareSecca

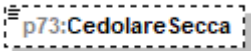
diagram	
type	DatoNP_Type

element Ritenute_Acconti_Sospesi_Type/SostitutivaRita

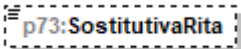
diagram	
type	DatoNP_Type

complexType **Ritenute_Lavoro_Dip_Type**

<p>diagram</p>	
<p>children</p>	<p>p73:Ritlrpef p73:RitRita p73:RitAddRegionale p73:RitAccAddComunale p73:RitSaldoAddComunale p73:RitAccAddComAnnoPres</p>

element **Ritenute_Lavoro_Dip_Type/Ritlrpef**

<p>diagram</p>	
<p>type</p>	<p>DatoNP_Type</p>

element **Ritenute_Lavoro_Dip_Type/RitRita**

<p>diagram</p>	
<p>type</p>	<p>DatoNP_Type</p>

element **Ritenute_Lavoro_Dip_Type/RitAddRegionale**

<p>diagram</p>	
<p>type</p>	<p>DatoNP_Type</p>

element **Ritenute_Lavoro_Dip_Type/RitAccAddComunale**

<p>diagram</p>	
<p>type</p>	<p>DatoNP_Type</p>

element **Ritenute_Lavoro_Dip_Type/RitSaldoAddComunale**

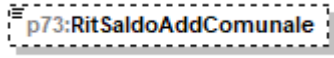
diagram	
type	DatoNP_Type

element **Ritenute_Lavoro_Dip_Type/RitAccAddComAnnoPres**

diagram	
type	DatoNP_Type

complexType **Rivalutazione_Terreni_Type**

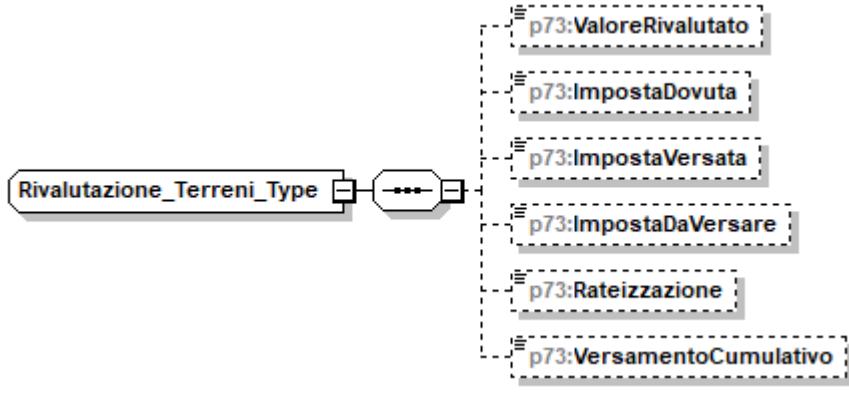
diagram	
children	p73:ValoreRivalutato p73:ImpostaDovuta p73:ImpostaVersata p73:ImpostaDaVersare p73:Rateizzazione p73:VersamentoCumulativo

element **Rivalutazione_Terreni_Type/ValoreRivalutato**

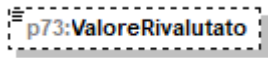
diagram	
type	DatoNP_Type

element **Rivalutazione_Terreni_Type/ImpostaDovuta**

diagram	
type	DatoNP_Type

element **Rivalutazione_Terreni_Type/ImpostaVersata**

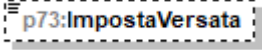
diagram	
type	DatoNP_Type

element **Rivalutazione_Terreni_Type/ImpostaDaVersare**

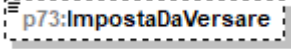
diagram	
type	DatoNP_Type

element **Rivalutazione_Terreni_Type/Rateizzazione**

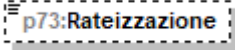
diagram	
type	DatoCB_Type

element **Rivalutazione_Terreni_Type/VersamentoCumulativo**

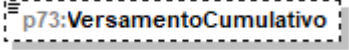
diagram	
type	DatoCB_Type

complexType **Sezione_Altri_Redd_Type**

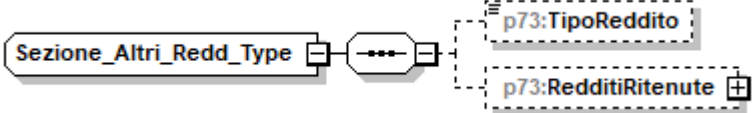
diagram	
children	p73:TipoReddito p73:RedditiRitenute

element **Sezione_Altri_Redd_Type/TipoReddito**

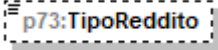
diagram																			
type	p73:Tipo_Reddito_Da1a8_Type																		
facets	<table border="1"> <thead> <tr> <th>Kind</th> <th>Value</th> </tr> </thead> <tbody> <tr><td>enumeration</td><td>1</td></tr> <tr><td>enumeration</td><td>2</td></tr> <tr><td>enumeration</td><td>3</td></tr> <tr><td>enumeration</td><td>4</td></tr> <tr><td>enumeration</td><td>5</td></tr> <tr><td>enumeration</td><td>6</td></tr> <tr><td>enumeration</td><td>7</td></tr> <tr><td>enumeration</td><td>8</td></tr> </tbody> </table>	Kind	Value	enumeration	1	enumeration	2	enumeration	3	enumeration	4	enumeration	5	enumeration	6	enumeration	7	enumeration	8
Kind	Value																		
enumeration	1																		
enumeration	2																		
enumeration	3																		
enumeration	4																		
enumeration	5																		
enumeration	6																		
enumeration	7																		
enumeration	8																		

element **Sezione_Altri_Redd_Type/RedditiRitenute**

diagram	
type	p73:Redditi_Ritenute_Type
children	p73:ImportoRedditi p73:ImportoRitenute

complexType **Sezione_Dati_Catastali_Recupero_Patrimonio_Edilizio_Type**

diagram	
children	p73:DatiCatastaliRecuperoPatrimonioEdilizio p73:DatiRegistrazioneAccatamentoRecuperoPatrimonio_Edilizio

element **Sezione_Dati_Catastali_Recupero_Patrimonio_Edilizio_Type/DatiCatastaliRecuperoPatrimonioEdilizio**

diagram	
type	extension of p73:Dati_Catastali_Recupero_Patrimonio_Edilizio_Type
children	p73:NOrdImmobile p73:Condominio p73:DatiCatastali

element

Sezione_Dati_Catastali_Recupero_Patrimonio_Edilizio_Type/DatiRegistrazioneAccatamentoRecuperoPatrimonio_Edilizio

diagram	
type	p73:Dati_Registrazione_Accatamento_Recupero_Patrimonio_Edilizio_Type
children	p73:NOrdImmobile p73:Condominio p73:EstremiRegistrazioneContratto p73:DomandaAccatamento

complexType Soggetto_Fiscale_730_Type

diagram	
children	p73:CodiceFiscale p73:Email p73:Telefono p73:Cellulare

element Soggetto_Fiscale_730_Type/CodiceFiscale

diagram	
type	DatoCF_Type

element Soggetto_Fiscale_730_Type/Email

diagram	
type	DatoEM_Type

element Soggetto_Fiscale_730_Type/Telefono

diagram	
---------	--

type	DatoAN_Type
------	-----------------------------

element **Soggetto_Fiscale_730_Type/Cellulare**

diagram	
type	DatoAN_Type

complexType **Soglie_Esenzione_Type**

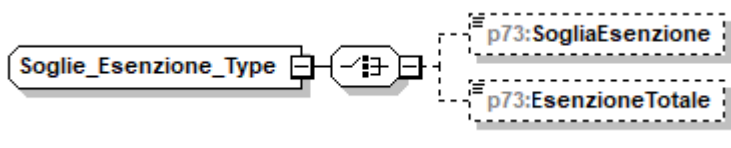
diagram	
children	p73:SogliaEsenzione p73:EsenzioneTotale

element **Soglie_Esenzione_Type/SogliaEsenzione**

diagram	
type	DatoNP_Type

element **Soglie_Esenzione_Type/EsenzioneTotale**

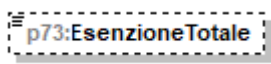
diagram							
type	restriction of DatoN1_Type						
facets	<table border="1"> <thead> <tr> <th>Kind</th> <th>Value</th> </tr> </thead> <tbody> <tr> <td>enumeration</td> <td>1</td> </tr> <tr> <td>enumeration</td> <td>2</td> </tr> </tbody> </table>	Kind	Value	enumeration	1	enumeration	2
Kind	Value						
enumeration	1						
enumeration	2						

complexType **Spese_Arredo_Giovani_Coppie_Type**

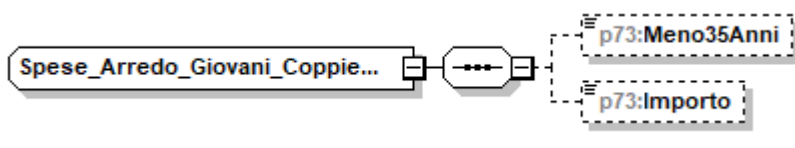
diagram	
children	p73:Meno35Anni p73:Importo

element **Spese_Arredo_Giovani_Coppie_Type/Meno35Anni**

diagram	
---------	---

type	DatoCB_Type
------	-----------------------------

element **Spese_Arredo_Giovani_Coppie_Type/Importo**

diagram	
type	DatoNP_Type

complexType **Spese_Arredo_Type**

diagram	
children	p73:NumeroRata p73:Importo

element **Spese_Arredo_Type/NumeroRata**

diagram																							
type	restriction of DatoNP_Type																						
facets	<table border="1"> <thead> <tr> <th>Kind</th> <th>Value</th> </tr> </thead> <tbody> <tr><td>enumeration</td><td>1</td></tr> <tr><td>enumeration</td><td>2</td></tr> <tr><td>enumeration</td><td>3</td></tr> <tr><td>enumeration</td><td>4</td></tr> <tr><td>enumeration</td><td>5</td></tr> <tr><td>enumeration</td><td>6</td></tr> <tr><td>enumeration</td><td>7</td></tr> <tr><td>enumeration</td><td>8</td></tr> <tr><td>enumeration</td><td>9</td></tr> <tr><td>enumeration</td><td>10</td></tr> </tbody> </table>	Kind	Value	enumeration	1	enumeration	2	enumeration	3	enumeration	4	enumeration	5	enumeration	6	enumeration	7	enumeration	8	enumeration	9	enumeration	10
Kind	Value																						
enumeration	1																						
enumeration	2																						
enumeration	3																						
enumeration	4																						
enumeration	5																						
enumeration	6																						
enumeration	7																						
enumeration	8																						
enumeration	9																						
enumeration	10																						

element **Spese_Arredo_Type/Importo**

diagram	
type	DatoNP_Type

complexType **Spese_Laurea_Ricarica_Type**

diagram	
children	p73:Codice p73:Anno p73:Importo p73:Percentuale p73:Rata

element **Spese_Laurea_Ricarica_Type/Codice**

diagram													
type	restriction of DatoNP_Type												
facets	<table border="1"> <thead> <tr> <th>Kind</th> <th>Value</th> </tr> </thead> <tbody> <tr> <td>enumeration</td> <td>1</td> </tr> <tr> <td>enumeration</td> <td>2</td> </tr> <tr> <td>enumeration</td> <td>3</td> </tr> <tr> <td>enumeration</td> <td>4</td> </tr> <tr> <td>enumeration</td> <td>5</td> </tr> </tbody> </table>	Kind	Value	enumeration	1	enumeration	2	enumeration	3	enumeration	4	enumeration	5
Kind	Value												
enumeration	1												
enumeration	2												
enumeration	3												
enumeration	4												
enumeration	5												

element **Spese_Laurea_Ricarica_Type/Anno**

diagram	
type	DatoDA_Type

element **Spese_Laurea_Ricarica_Type/Importo**

diagram	
type	DatoNP_Type

element **Spese_Laurea_Ricarica_Type/Percentuale**

diagram							
type	restriction of DatoNP_Type						
facets	<table border="1"> <thead> <tr> <th>Kind</th> <th>Value</th> </tr> </thead> <tbody> <tr> <td>enumeration</td> <td>1</td> </tr> <tr> <td>enumeration</td> <td>2</td> </tr> </tbody> </table>	Kind	Value	enumeration	1	enumeration	2
Kind	Value						
enumeration	1						
enumeration	2						

element **Spese_Laurea_Ricarica_Type/Rata**

diagram							
type	restriction of DatoNP_Type						
facets	<table border="1"> <thead> <tr> <th>Kind</th> <th>Value</th> </tr> </thead> <tbody> <tr> <td>enumeration</td> <td>1</td> </tr> <tr> <td>enumeration</td> <td>2</td> </tr> </tbody> </table>	Kind	Value	enumeration	1	enumeration	2
Kind	Value						
enumeration	1						
enumeration	2						

complexType **Spese_Leasing_Type**

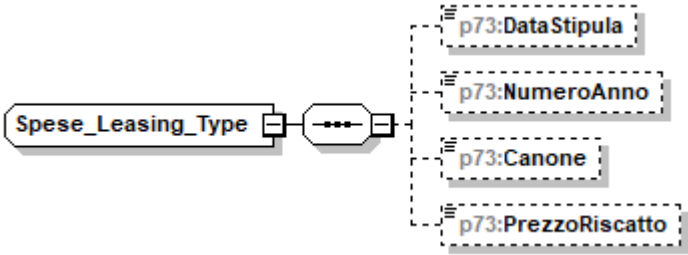
diagram	
children	p73:DataStipula p73:NumeroAnno p73:Canone p73:PrezzoRiscatto

element **Spese_Leasing_Type/DataStipula**

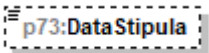
diagram	
type	DatoDT_Type

element **Spese_Leasing_Type/NumeroAnno**

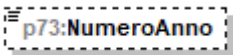
diagram															
type	restriction of DatoNP_Type														
facets	<table border="1"> <thead> <tr> <th>Kind</th> <th>Value</th> </tr> </thead> <tbody> <tr> <td>enumeration</td> <td>3</td> </tr> <tr> <td>enumeration</td> <td>4</td> </tr> <tr> <td>enumeration</td> <td>5</td> </tr> <tr> <td>enumeration</td> <td>6</td> </tr> <tr> <td>enumeration</td> <td>7</td> </tr> <tr> <td>enumeration</td> <td>8</td> </tr> </tbody> </table>	Kind	Value	enumeration	3	enumeration	4	enumeration	5	enumeration	6	enumeration	7	enumeration	8
Kind	Value														
enumeration	3														
enumeration	4														
enumeration	5														
enumeration	6														
enumeration	7														
enumeration	8														

element **Spese_Leasing_Type/Canone**

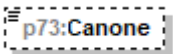
diagram	
type	restriction of DatoNP_Type

element **Spese_Leasing_Type/PrezzoRiscatto**

diagram	
type	restriction of DatoNP_Type

complexType **Spese_Rateizzate_Anni_Precedenti_Type**

diagram	
children	p73:Codice p73:Importo

element **Spese_Rateizzate_Anni_Precedenti_Type/Codice**

diagram									
type	p73:Codice Spese_Rateizzate_Anni_Precedenti_Type								
facets	<table border="1"> <thead> <tr> <th>Kind</th> <th>Value</th> </tr> </thead> <tbody> <tr> <td>enumeration</td> <td>2</td> </tr> <tr> <td>enumeration</td> <td>3</td> </tr> <tr> <td>enumeration</td> <td>4</td> </tr> </tbody> </table>	Kind	Value	enumeration	2	enumeration	3	enumeration	4
Kind	Value								
enumeration	2								
enumeration	3								
enumeration	4								

element **Spese_Rateizzate_Anni_Precedenti_Type/Importo**

diagram	
type	DatoNP_Type

complexType **Spese_Rateizzate_Type**

diagram	
children	p73:Codice p73:Importo

element **Spese_Rateizzate_Type/Codice**

diagram	
type	p73:Codice Spese_Rateizzate_Type

facets	Kind	Value
	enumeration	1
	enumeration	2
	enumeration	3
	enumeration	4

element **Spese_Rateizzate_Type/Importo**

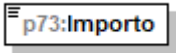
diagram	
type	DatoNP_Type

complexType **Tassazione_Separata_Type**

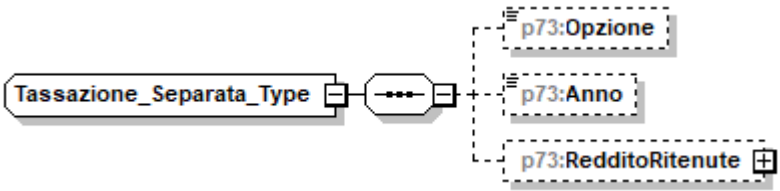
diagram	
children	p73:Opzione p73:Anno p73:RedditoRitenute

element **Tassazione_Separata_Type/Opzione**

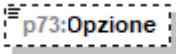
diagram	
type	DatoCB_Type

element **Tassazione_Separata_Type/Anno**

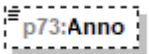
diagram	
type	DatoDA_Type

element **Tassazione_Separata_Type/RedditoRitenute**

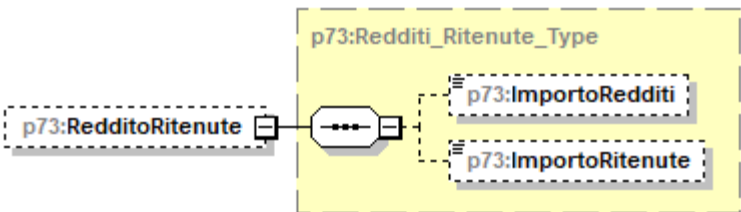
diagram	
type	p73:Redditi_Ritenute_Type

children	p73:ImportoRedditi p73:ImportoRitenute
----------	--

complexType **Terreno_Type**

diagram	
children	p73:RedDominicale p73:Titolo p73:RedAgrario p73:GiorniPossesso p73:PercPossesso p73:CanoneVincolistico p73:CasiParticolari p73:CasellaContinuazione p73:CasellalmuNonDovuta p73:CasellaColtivatoreDiretto

element **Terreno_Type/RedDominicale**

diagram	
type	DatoNP_Type

element **Terreno_Type/Titolo**

diagram																			
type	p73:Titolo Terreno_Type																		
facets	<table border="1"> <thead> <tr> <th>Kind</th> <th>Value</th> </tr> </thead> <tbody> <tr><td>enumeration</td><td>1</td></tr> <tr><td>enumeration</td><td>2</td></tr> <tr><td>enumeration</td><td>3</td></tr> <tr><td>enumeration</td><td>4</td></tr> <tr><td>enumeration</td><td>5</td></tr> <tr><td>enumeration</td><td>6</td></tr> <tr><td>enumeration</td><td>7</td></tr> <tr><td>enumeration</td><td>10</td></tr> </tbody> </table>	Kind	Value	enumeration	1	enumeration	2	enumeration	3	enumeration	4	enumeration	5	enumeration	6	enumeration	7	enumeration	10
Kind	Value																		
enumeration	1																		
enumeration	2																		
enumeration	3																		
enumeration	4																		
enumeration	5																		
enumeration	6																		
enumeration	7																		
enumeration	10																		

element **Terreno_Type/RedAgrario**

diagram	
type	DatoNP_Type

element **Terreno_Type/GiorniPossesso**

diagram	
type	DatoGA_Type

element **Terreno_Type/PercPossesso**

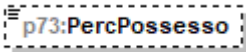
diagram	
type	DatoPC_Type

element **Terreno_Type/CanoneVincolistico**

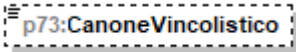
diagram	
type	DatoNP_Type

element **Terreno_Type/CasiParticolari**

diagram											
type	p73:Casi Particolari Terreni_Type										
facets	<table border="1"> <thead> <tr> <th>Kind</th> <th>Value</th> </tr> </thead> <tbody> <tr> <td>enumeration</td> <td>2</td> </tr> <tr> <td>enumeration</td> <td>3</td> </tr> <tr> <td>enumeration</td> <td>4</td> </tr> <tr> <td>enumeration</td> <td>6</td> </tr> </tbody> </table>	Kind	Value	enumeration	2	enumeration	3	enumeration	4	enumeration	6
Kind	Value										
enumeration	2										
enumeration	3										
enumeration	4										
enumeration	6										

element **Terreno_Type/CasellaContinuazione**

diagram	
type	DatoCB_Type

element **Terreno_Type/CasellalmuNonDovuta**

diagram	
type	DatoCB_Type

element **Terreno_Type/CasellaColtivatoreDiretto**

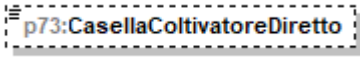
diagram	
type	DatoCB_Type

complexType **Ulteriori_Dati_Type**

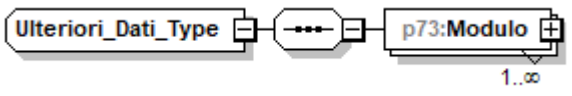
diagram	
children	p73:Modulo

element **Ulteriori_Dati_Type/Modulo**

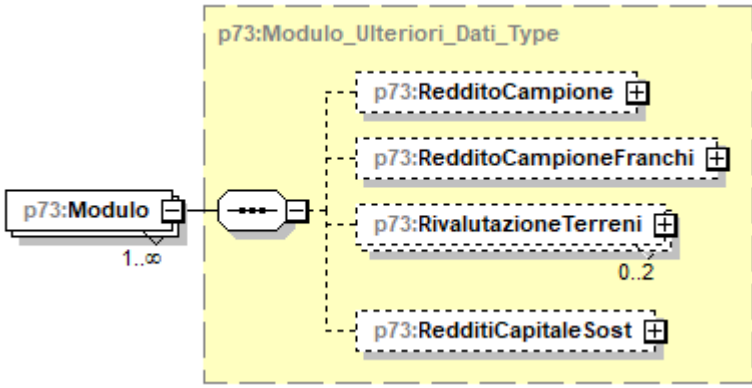
diagram	
type	p73:Modulo_Ulteriori_Dati_Type
children	p73:RedditoCampione p73:RedditoCampioneFranchi p73:RivalutazioneTerreni p73:RedditiCapitaleSost

simpleType **Anno_Anticipazione_Fondo_Pensione_Type**

type	restriction of DatoNP_Type																
facets	<table border="1"> <thead> <tr> <th>Kind</th> <th>Value</th> </tr> </thead> <tbody> <tr> <td>enumeration</td> <td>2007</td> </tr> <tr> <td>enumeration</td> <td>2008</td> </tr> <tr> <td>enumeration</td> <td>2009</td> </tr> <tr> <td>enumeration</td> <td>2010</td> </tr> <tr> <td>enumeration</td> <td>2011</td> </tr> <tr> <td>enumeration</td> <td>2012</td> </tr> <tr> <td>enumeration</td> <td>2013</td> </tr> </tbody> </table>	Kind	Value	enumeration	2007	enumeration	2008	enumeration	2009	enumeration	2010	enumeration	2011	enumeration	2012	enumeration	2013
Kind	Value																
enumeration	2007																
enumeration	2008																
enumeration	2009																
enumeration	2010																
enumeration	2011																
enumeration	2012																
enumeration	2013																

	enumeration 2014
	enumeration 2015
	enumeration 2016
	enumeration 2017
	enumeration 2018
	enumeration 2019
	enumeration 2020
	enumeration 2021
	enumeration 2022

simpleType Anno_Patrimonio_Edilizio_Situazioni_Particolari_Type

type	restriction of DatoNP_Type
facets	Kind Value enumeration 2011

simpleType Anno_Recupero_Patrimonio_Edilizio_Type

type	restriction of DatoNP_Type
facets	Kind Value enumeration 2014 enumeration 2015 enumeration 2016 enumeration 2017 enumeration 2018 enumeration 2019 enumeration 2020 enumeration 2021 enumeration 2022 enumeration 2023

simpleType Anno_Risparmio_Energetico_Type

type	restriction of DatoNP_Type
facets	Kind Value enumeration 2008 enumeration 2014 enumeration 2015 enumeration 2016 enumeration 2017 enumeration 2018 enumeration 2019 enumeration 2020 enumeration 2021 enumeration 2022 enumeration 2023

simpleType Casella_Codice_Type

type	restriction of DatoN1_Type
facets	Kind Value enumeration 4

simpleType Casi_Particolari_Fabbricato_Type

type	restriction of DatoN1_Type
------	--

facets	Kind	Value
	enumeration	1
	enumeration	3
	enumeration	4
	enumeration	5
	enumeration	6
	enumeration	7
	enumeration	8

simpleType Casi_Particolari_Risp_Ener_Type

type	restriction of DatoN1_Type	
facets	Kind	Value
	enumeration	1
	enumeration	2
	enumeration	3

simpleType Casi_Particolari_Terreni_Type

type	restriction of DatoN1_Type	
facets	Kind	Value
	enumeration	2
	enumeration	3
	enumeration	4
	enumeration	6

simpleType Codice_Altre_Detrazioni_Type

type	restriction of DatoNP_Type	
facets	Kind	Value
	enumeration	1
	enumeration	2

simpleType Codice_Altre_Spese_Type

type	restriction of DatoNP_Type	
facets	Kind	Value
	enumeration	8
	enumeration	9
	enumeration	10
	enumeration	11
	enumeration	12
	enumeration	13
	enumeration	14
	enumeration	15
	enumeration	16
	enumeration	17
	enumeration	18
	enumeration	20
	enumeration	21
	enumeration	22
	enumeration	24
	enumeration	25
	enumeration	26
	enumeration	27
	enumeration	28
	enumeration	29
	enumeration	30
	enumeration	31

	enumeration 32
	enumeration 33
	enumeration 35
	enumeration 36
	enumeration 38
	enumeration 39
	enumeration 40
	enumeration 43
	enumeration 44
	enumeration 45
	enumeration 46
	enumeration 47
	enumeration 61
	enumeration 62
	enumeration 71
	enumeration 76
	enumeration 81
	enumeration 99

simpleType Codice_Altri_Oneri_Type

type	restriction of DatoNP_Type																
facets	<table border="1"> <thead> <tr> <th>Kind</th> <th>Value</th> </tr> </thead> <tbody> <tr> <td>enumeration</td> <td>6</td> </tr> <tr> <td>enumeration</td> <td>7</td> </tr> <tr> <td>enumeration</td> <td>8</td> </tr> <tr> <td>enumeration</td> <td>9</td> </tr> <tr> <td>enumeration</td> <td>12</td> </tr> <tr> <td>enumeration</td> <td>13</td> </tr> <tr> <td>enumeration</td> <td>21</td> </tr> </tbody> </table>	Kind	Value	enumeration	6	enumeration	7	enumeration	8	enumeration	9	enumeration	12	enumeration	13	enumeration	21
Kind	Value																
enumeration	6																
enumeration	7																
enumeration	8																
enumeration	9																
enumeration	12																
enumeration	13																
enumeration	21																

simpleType Codice_Canone_Type

type	restriction of DatoN1_Type										
facets	<table border="1"> <thead> <tr> <th>Kind</th> <th>Value</th> </tr> </thead> <tbody> <tr> <td>enumeration</td> <td>1</td> </tr> <tr> <td>enumeration</td> <td>2</td> </tr> <tr> <td>enumeration</td> <td>3</td> </tr> <tr> <td>enumeration</td> <td>4</td> </tr> </tbody> </table>	Kind	Value	enumeration	1	enumeration	2	enumeration	3	enumeration	4
Kind	Value										
enumeration	1										
enumeration	2										
enumeration	3										
enumeration	4										

simpleType Codice_Evento_Eccezionale_Type

type	restriction of DatoNP_Type										
facets	<table border="1"> <thead> <tr> <th>Kind</th> <th>Value</th> </tr> </thead> <tbody> <tr> <td>enumeration</td> <td>1</td> </tr> <tr> <td>enumeration</td> <td>2</td> </tr> <tr> <td>enumeration</td> <td>3</td> </tr> <tr> <td>enumeration</td> <td>99</td> </tr> </tbody> </table>	Kind	Value	enumeration	1	enumeration	2	enumeration	3	enumeration	99
Kind	Value										
enumeration	1										
enumeration	2										
enumeration	3										
enumeration	99										

simpleType Codice_Spese_Rateizzate_Anni_Precedenti_Type

type	restriction of DatoNP_Type								
facets	<table border="1"> <thead> <tr> <th>Kind</th> <th>Value</th> </tr> </thead> <tbody> <tr> <td>enumeration</td> <td>2</td> </tr> <tr> <td>enumeration</td> <td>3</td> </tr> <tr> <td>enumeration</td> <td>4</td> </tr> </tbody> </table>	Kind	Value	enumeration	2	enumeration	3	enumeration	4
Kind	Value								
enumeration	2								
enumeration	3								
enumeration	4								

simpleType Codice_Spese_Rateizzate_Type

type	restriction of DatoNP_Type	
facets	Kind	Value
	enumeration	1
	enumeration	2
	enumeration	3
	enumeration	4

simpleType Fabbricato_Agev_Numero_Rigo_Type

type	restriction of DatoNP_Type	
facets	Kind	Value
	enumeration	1
	enumeration	2
	enumeration	3
	enumeration	4
	enumeration	5
	enumeration	6
	enumeration	7
	enumeration	8
	enumeration	9
	enumeration	10

simpleType Indeterminato_Determinato_Type

type	restriction of DatoN1_Type	
facets	Kind	Value
	enumeration	1
	enumeration	2

simpleType Mesi_Type

type	restriction of DatoNP_Type	
facets	Kind	Value
	enumeration	1
	enumeration	2
	enumeration	3
	enumeration	4
	enumeration	5
	enumeration	6
	enumeration	7
	enumeration	8
	enumeration	9
	enumeration	10
	enumeration	11
	enumeration	12

simpleType Numero_Rata_Risparmio_Energetico_Type

type	restriction of DatoNP_Type	
facets	Kind	Value
	enumeration	1
	enumeration	2
	enumeration	3
	enumeration	4
	enumeration	5
	enumeration	6
	enumeration	7

	enumeration 8
	enumeration 9
	enumeration 10

simpleType Numero_Rate5o10_Type

type	restriction of DatoNP_Type						
facets	<table border="1"> <thead> <tr> <th>Kind</th> <th>Value</th> </tr> </thead> <tbody> <tr> <td>enumeration</td> <td>5</td> </tr> <tr> <td>enumeration</td> <td>10</td> </tr> </tbody> </table>	Kind	Value	enumeration	5	enumeration	10
Kind	Value						
enumeration	5						
enumeration	10						

simpleType Periodo_Spese_Ristrutturazione_Type

type	restriction of DatoNP_Type																																										
facets	<table border="1"> <thead> <tr> <th>Kind</th> <th>Value</th> </tr> </thead> <tbody> <tr><td>enumeration</td><td>2</td></tr> <tr><td>enumeration</td><td>3</td></tr> <tr><td>enumeration</td><td>4</td></tr> <tr><td>enumeration</td><td>5</td></tr> <tr><td>enumeration</td><td>6</td></tr> <tr><td>enumeration</td><td>7</td></tr> <tr><td>enumeration</td><td>8</td></tr> <tr><td>enumeration</td><td>9</td></tr> <tr><td>enumeration</td><td>10</td></tr> <tr><td>enumeration</td><td>11</td></tr> <tr><td>enumeration</td><td>12</td></tr> <tr><td>enumeration</td><td>13</td></tr> <tr><td>enumeration</td><td>15</td></tr> <tr><td>enumeration</td><td>16</td></tr> <tr><td>enumeration</td><td>17</td></tr> <tr><td>enumeration</td><td>18</td></tr> <tr><td>enumeration</td><td>19</td></tr> <tr><td>enumeration</td><td>20</td></tr> <tr><td>enumeration</td><td>21</td></tr> <tr><td>enumeration</td><td>22</td></tr> </tbody> </table>	Kind	Value	enumeration	2	enumeration	3	enumeration	4	enumeration	5	enumeration	6	enumeration	7	enumeration	8	enumeration	9	enumeration	10	enumeration	11	enumeration	12	enumeration	13	enumeration	15	enumeration	16	enumeration	17	enumeration	18	enumeration	19	enumeration	20	enumeration	21	enumeration	22
Kind	Value																																										
enumeration	2																																										
enumeration	3																																										
enumeration	4																																										
enumeration	5																																										
enumeration	6																																										
enumeration	7																																										
enumeration	8																																										
enumeration	9																																										
enumeration	10																																										
enumeration	11																																										
enumeration	12																																										
enumeration	13																																										
enumeration	15																																										
enumeration	16																																										
enumeration	17																																										
enumeration	18																																										
enumeration	19																																										
enumeration	20																																										
enumeration	21																																										
enumeration	22																																										

simpleType Rate10_Type

type	restriction of DatoNP_Type																						
facets	<table border="1"> <thead> <tr> <th>Kind</th> <th>Value</th> </tr> </thead> <tbody> <tr><td>enumeration</td><td>1</td></tr> <tr><td>enumeration</td><td>2</td></tr> <tr><td>enumeration</td><td>3</td></tr> <tr><td>enumeration</td><td>4</td></tr> <tr><td>enumeration</td><td>5</td></tr> <tr><td>enumeration</td><td>6</td></tr> <tr><td>enumeration</td><td>7</td></tr> <tr><td>enumeration</td><td>8</td></tr> <tr><td>enumeration</td><td>9</td></tr> <tr><td>enumeration</td><td>10</td></tr> </tbody> </table>	Kind	Value	enumeration	1	enumeration	2	enumeration	3	enumeration	4	enumeration	5	enumeration	6	enumeration	7	enumeration	8	enumeration	9	enumeration	10
Kind	Value																						
enumeration	1																						
enumeration	2																						
enumeration	3																						
enumeration	4																						
enumeration	5																						
enumeration	6																						
enumeration	7																						
enumeration	8																						
enumeration	9																						
enumeration	10																						

simpleType Rate5_Type

type	restriction of DatoNP_Type				
facets	<table border="1"> <thead> <tr> <th>Kind</th> <th>Value</th> </tr> </thead> <tbody> <tr> <td>enumeration</td> <td>5</td> </tr> </tbody> </table>	Kind	Value	enumeration	5
Kind	Value				
enumeration	5				

simpleType Rate_Risparmio_Energetico_Type

type	restriction of DatoNP_Type	
facets	Kind	Value
	enumeration	6
	enumeration	7
	enumeration	8
	enumeration	9
	enumeration	10

simpleType Reintegro_Totale_Parziale_Type

type	restriction of DatoN1_Type	
facets	Kind	Value
	enumeration	1
	enumeration	2

simpleType Rideterminazione_Rate_Type

type	restriction of DatoNP_Type	
facets	Kind	Value
	enumeration	10

simpleType Ripart_Risparmio_Energetico_Type

type	restriction of DatoNP_Type	
facets	Kind	Value
	enumeration	9
	enumeration	10

simpleType Serie_Registrazione_Contratto_Type

type	restriction of DatoAN_Type	
facets	Kind	Value
	enumeration	3
	enumeration	3A
	enumeration	3B
	enumeration	3P
	enumeration	1T
	enumeration	3T

simpleType Terreni_Urbano_Type

type	restriction of DatoAN_Type	
facets	Kind	Value
	enumeration	T
	enumeration	U

simpleType Tipo_Inquilino_Type

type	restriction of DatoNP_Type	
facets	Kind	Value
	enumeration	1
	enumeration	2

	enumeration	4
--	-------------	---

simpleType Tipo_Intervento_Type

type	restriction of DatoNP_Type	
facets	Kind	Value
	enumeration	1
	enumeration	2
	enumeration	3
	enumeration	4
	enumeration	5
	enumeration	6
	enumeration	7
	enumeration	8
	enumeration	9
	enumeration	10
	enumeration	11
	enumeration	12
	enumeration	13
	enumeration	14
	enumeration	15
	enumeration	16
	enumeration	30
	enumeration	31
	enumeration	32
	enumeration	33

simpleType Tipo_Reddito_Da1a12_Type

type	restriction of DatoNP_Type	
facets	Kind	Value
	enumeration	1
	enumeration	2
	enumeration	3
	enumeration	4
	enumeration	5
	enumeration	6
	enumeration	7
	enumeration	8
	enumeration	9
	enumeration	10
	enumeration	11
	enumeration	12

simpleType Tipo_Reddito_Da1a3_Type

type	restriction of DatoN1_Type	
facets	Kind	Value
	enumeration	1
	enumeration	2
	enumeration	3

simpleType Tipo_Reddito_Da1a4_Type

type	restriction of DatoN1_Type	
facets	Kind	Value
	enumeration	1
	enumeration	2
	enumeration	3

	enumeration	4
--	-------------	---

simpleType Tipo_Redito_Da1a6_Type

type	restriction of DatoN1_Type	
facets	Kind	Value
	enumeration	1
	enumeration	2
	enumeration	3
	enumeration	4
	enumeration	5
	enumeration	6

simpleType Tipo_Redito_Da1a8_Type

type	restriction of DatoNP_Type	
facets	Kind	Value
	enumeration	1
	enumeration	2
	enumeration	3
	enumeration	4
	enumeration	5
	enumeration	6
	enumeration	7
	enumeration	8

simpleType Tipo_Redito_Da1a9_Type

type	restriction of DatoNP_Type	
facets	Kind	Value
	enumeration	1
	enumeration	2
	enumeration	3
	enumeration	4
	enumeration	5
	enumeration	6
	enumeration	7
	enumeration	8
	enumeration	9

simpleType Titolo_Terreno_Type

type	restriction of DatoNP_Type	
facets	Kind	Value
	enumeration	1
	enumeration	2
	enumeration	3
	enumeration	4
	enumeration	5
	enumeration	6
	enumeration	7
	enumeration	10

simpleType Utilizzo_Fabbricato_Type

type	restriction of DatoNP_Type	
------	--	--

facets	Kind	Value
	enumeration	1
	enumeration	2
	enumeration	3
	enumeration	4
	enumeration	5
	enumeration	8
	enumeration	9
	enumeration	10
	enumeration	11
	enumeration	12
	enumeration	14
	enumeration	15
	enumeration	16
	enumeration	17

element ElencoFonti

diagram	
type	p73:ElencoFontiType
children	p73:Fonte

element Sintetico730

diagram	
children	p73:DatiAnagrafici p73:DataElaborazione p73:ElencoFonti

element Sintetico730/DatiAnagrafici

diagram	
type	p73:DatiAnagraficiType
children	p73:Anagrafica

element **Sintetico730/DataElaborazione**

diagram	
type	p73:DataType

complexType **AnagraficaType**

diagram	
children	p73:CodiceFiscale p73:Nome p73:Cognome

element **AnagraficaType/CodiceFiscale**

diagram	
type	xs:string

element **AnagraficaType/Nome**

diagram	
type	xs:string

element **AnagraficaType/Cognome**

diagram	
type	xs:string

complexType **DatiAnagraficiType**

diagram	
children	p73:Anagrafica

element **DatiAnagraficiType/Anagrafica**

diagram	
type	p73:AnagraficaType
children	p73:CodiceFiscale p73:Nome p73:Cognome

complexType **DettaglioFonteType**

diagram	
children	p73:Testata p73:TestataImporto p73:TestataUtilizzo p73:Dettaglio

element **DettaglioFonteType/Testata**

diagram	
type	xs:string

element **DettaglioFonteType/TestataImporto**

diagram	
type	xs:string

element **DettaglioFonteType/TestataUtilizzo**

diagram	
type	xs:string

element **DettaglioFonteType/Dettaglio**

diagram	
type	p73:DettaglioType
children	p73:Contenuto p73:Importo p73:Utilizzo

complexType **DettaglioType**

diagram	
children	p73:Contenuto p73:Importo p73:Utilizzo

element **DettaglioType/Contenuto**

diagram	
type	xs:string

element **DettaglioType/Importo**

diagram	
type	p73:ImportoType

element **DettaglioType/Utilizzo**

diagram	
type	xs:string

complexType ElencoFontiType

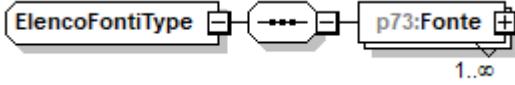
diagram	
children	p73:Fonte

element ElencoFontiType/Fonte

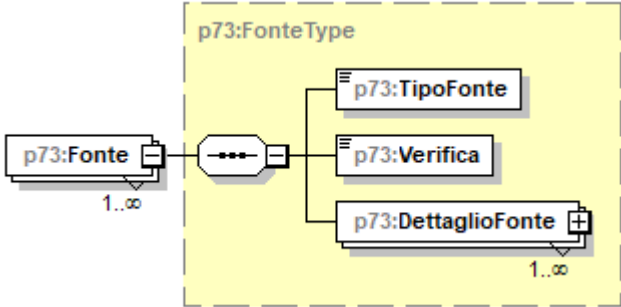
diagram	
type	p73:FonteType
children	p73:TipoFonte p73:Verifica p73:DettaglioFonte

complexType FonteType

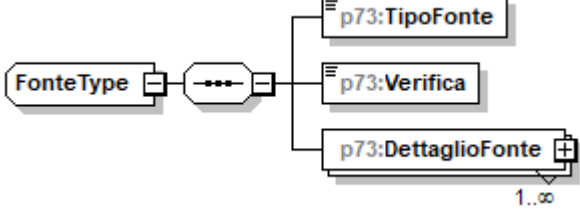
diagram	
children	p73:TipoFonte p73:Verifica p73:DettaglioFonte

element FonteType/TipoFonte

diagram	
type	xs:string

element FonteType/Verifica

diagram	
---------	---

type	xs:int
------	---------------

element **FonteType/DettaglioFonte**

diagram	
type	p73:DettaglioFonteType
children	p73:Testata p73:TestataImporto p73:TestataUtilizzo p73:Dettaglio

simpleType **DataType**

type	restriction of xs:string
------	---------------------------------

simpleType **ImportoType**

type	restriction of xs:string
------	---------------------------------

simpleType **DatoAN_Type**

type	restriction of xs:string
------	---------------------------------

simpleType **DatoCB12_Type**

type	restriction of xs:byte
------	-------------------------------

simpleType **DatoCB_Type**

type	restriction of xs:byte
------	-------------------------------

simpleType **DatoCF_Type**

type	restriction of xs:string
------	---------------------------------

simpleType DatoCN_Type

type	restriction of xs:string
------	---------------------------------

simpleType DatoCP_Type

type	restriction of xs:string
------	---------------------------------

simpleType DatoD6_Type

type	restriction of xs:string
------	---------------------------------

simpleType DatoDA_Type

type	restriction of xs:string
------	---------------------------------

simpleType DatoDN_Type

type	restriction of xs:string
------	---------------------------------

simpleType DatoDT_Type

type	restriction of xs:string
------	---------------------------------

simpleType DatoEM_Type

type	restriction of xs:string
------	---------------------------------

simpleType DatoGA_Type

type	restriction of xs:string
------	---------------------------------

simpleType DatoN1_Type

type	restriction of xs:string
------	---------------------------------

simpleType DatoNP_Type

type	restriction of xs:string
------	---------------------------------

simpleType DatoNU_Type

type	restriction of xs:string
------	---------------------------------

simpleType **DatoPC_Type**

type	restriction of xs:string
------	---------------------------------

simpleType **DatoPI_Type**

type	restriction of xs:string
------	---------------------------------

simpleType **DatoQU_Type**

type	restriction of xs:string
------	---------------------------------

simpleType **DatoTL_Type**

type	restriction of xs:string
------	---------------------------------

simpleType **DatoVP_Type**

type	restriction of xs:string
------	---------------------------------

element **Documento**

diagram					
type	Documento_Type				
attributes	Name identificativo	Type Identificativo_Type	Use required	Default	Fixed

complexType **Documento_Type**

diagram					
attributes	Name identificativo	Type Identificativo_Type	Use required	Default	Fixed

attribute **Documento_Type/@identificativo**

type	Identificativo_Type
------	-------------------------------------

simpleType **Identificativo_Type**

type	restriction of xs:string
------	--------------------------

complexType **Dati_Anagrafici_Type**

diagram	
children	Cognome Nome Sesso DataNascita ComuneNascita ProvinciaNascita

element **Dati_Anagrafici_Type/Cognome**

diagram	
type	DatoAN_Type

element **Dati_Anagrafici_Type/Nome**

diagram	
type	DatoAN_Type

element **Dati_Anagrafici_Type/Sesso**

diagram							
type	Sesso_Type						
facets	<table border="1"> <thead> <tr> <th>Kind</th> <th>Value</th> </tr> </thead> <tbody> <tr> <td>enumeration</td> <td>M</td> </tr> <tr> <td>enumeration</td> <td>F</td> </tr> </tbody> </table>	Kind	Value	enumeration	M	enumeration	F
Kind	Value						
enumeration	M						
enumeration	F						

element **Dati_Anagrafici_Type/DataNascita**

diagram	
type	DatoDT_Type

element **Dati_Anagrafici_Type/ComuneNascita**

diagram	
type	DatoAN_Type

element **Dati_Anagrafici_Type/ProvinciaNascita**

diagram	
type	PN_Type

complexType **Dati_Sottoscrittore_Type**

diagram	
children	CodiceFiscale CodiceCarica CodiceFiscaleSocieta DatiAnagrafici ResidenzaEstera Telefono DataCarica InizioProcedura ProceduraNonTerminata FineProcedura

element **Dati_Sottoscrittore_Type/CodiceFiscale**

diagram	
type	DatoCF_Type

element **Dati_Sottoscrittore_Type/CodiceCarica**

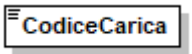
diagram																																	
type	Codice_Carica_Type																																
facets	<table border="1"> <thead> <tr> <th>Kind</th> <th>Value</th> </tr> </thead> <tbody> <tr><td>enumeration</td><td>1</td></tr> <tr><td>enumeration</td><td>2</td></tr> <tr><td>enumeration</td><td>3</td></tr> <tr><td>enumeration</td><td>4</td></tr> <tr><td>enumeration</td><td>5</td></tr> <tr><td>enumeration</td><td>6</td></tr> <tr><td>enumeration</td><td>7</td></tr> <tr><td>enumeration</td><td>8</td></tr> <tr><td>enumeration</td><td>9</td></tr> <tr><td>enumeration</td><td>10</td></tr> <tr><td>enumeration</td><td>11</td></tr> <tr><td>enumeration</td><td>12</td></tr> <tr><td>enumeration</td><td>13</td></tr> <tr><td>enumeration</td><td>14</td></tr> <tr><td>enumeration</td><td>15</td></tr> </tbody> </table>	Kind	Value	enumeration	1	enumeration	2	enumeration	3	enumeration	4	enumeration	5	enumeration	6	enumeration	7	enumeration	8	enumeration	9	enumeration	10	enumeration	11	enumeration	12	enumeration	13	enumeration	14	enumeration	15
Kind	Value																																
enumeration	1																																
enumeration	2																																
enumeration	3																																
enumeration	4																																
enumeration	5																																
enumeration	6																																
enumeration	7																																
enumeration	8																																
enumeration	9																																
enumeration	10																																
enumeration	11																																
enumeration	12																																
enumeration	13																																
enumeration	14																																
enumeration	15																																

element **Dati_Sottoscrittore_Type/CodiceFiscaleSocieta**

diagram	
type	DatoCN_Type

element **Dati_Sottoscrittore_Type/DatiAnagrafici**

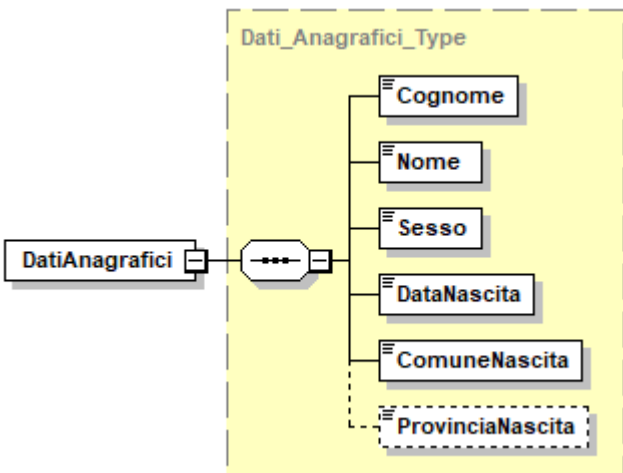
diagram	 <p>The diagram illustrates the structure of the Dati_Anagrafici_Type. It shows a box labeled DatiAnagrafici connected to a dashed box labeled Dati_Anagrafici_Type. Inside this dashed box, there are six sub-elements: Cognome, Nome, Sesso, DataNascita, ComuneNascita, and ProvinciaNascita. The ProvinciaNascita element is shown with a dashed border, indicating it might be optional or part of a different configuration.</p>
---------	---

type	Dati_Anagrafici_Type
children	Cognome Nome Sesso DataNascita ComuneNascita ProvinciaNascita

element **Dati_Sottoscrittore_Type/ResidenzaEstera**

diagram	
type	Residenza_Estera_Type
children	CodiceStatoEstero StatoFederato LocalitaEstero IndirizzoEstero

element **Dati_Sottoscrittore_Type/Telefono**

diagram	
type	DatoTL_Type

element **Dati_Sottoscrittore_Type/DataCarica**

diagram	
type	DatoDT_Type

element **Dati_Sottoscrittore_Type/InizioProcedura**

diagram	
type	DatoDT_Type

element **Dati_Sottoscrittore_Type/ProceduraNonTerminata**

diagram	
type	DatoCB_Type

element **Dati_Sottoscrittore_Type/FineProcedura**

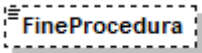
diagram	
type	DatoDT_Type

complexType **Domicilio_EE_Type**

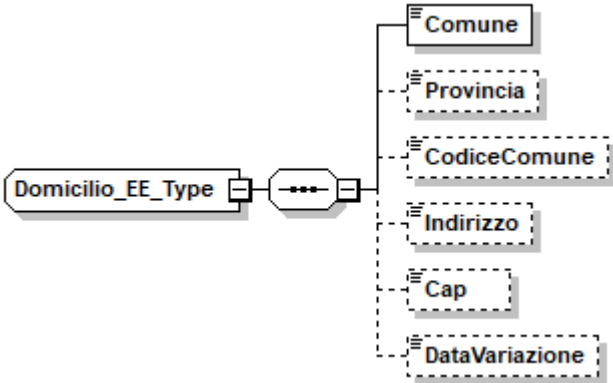
diagram	
children	Comune Provincia CodiceComune Indirizzo Cap DataVariazione

element **Domicilio_EE_Type/Comune**

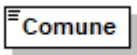
diagram	
type	DatoAN_Type

element **Domicilio_EE_Type/Provincia**

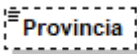
diagram	
type	PE_Type

element **Domicilio_EE_Type/CodiceComune**

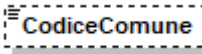
diagram	
type	DatoAN_Type

element **Domicilio_EE_Type/Indirizzo**

diagram	
type	DatoAN_Type

element **Domicilio_EE_Type/Cap**

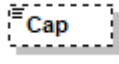
diagram	
type	DatoCP_Type

element **Domicilio_EE_Type/DataVariazione**

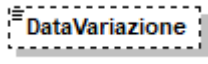
diagram	
type	DatoD6_Type

complexType **Domicilio_Fiscale_Type**

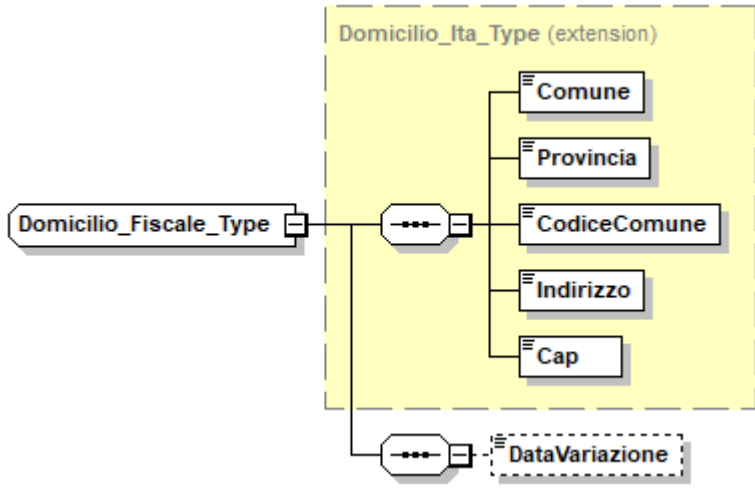
diagram	
type	extension of Domicilio_Ita_Type
children	Comune Provincia CodiceComune Indirizzo Cap DataVariazione

element **Domicilio_Fiscale_Type/DataVariazione**

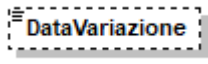
diagram	
type	DatoD6_Type

complexType **Domicilio_Ita_Type**

<p>diagram</p>	
<p>children</p>	<p>Comune Provincia CodiceComune Indirizzo Cap</p>

element **Domicilio_Ita_Type/Comune**

<p>diagram</p>	
<p>type</p>	<p>DatoAN_Type</p>

element **Domicilio_Ita_Type/Provincia**

<p>diagram</p>	
<p>type</p>	<p>PR_Type</p>

element **Domicilio_Ita_Type/CodiceComune**

<p>diagram</p>	
<p>type</p>	<p>DatoAN_Type</p>

element **Domicilio_Ita_Type/Indirizzo**

<p>diagram</p>	
<p>type</p>	<p>DatoAN_Type</p>

element **Domicilio_Ita_Type/Cap**

<p>diagram</p>	
----------------	--

type	DatoCP_Type
------	-----------------------------

complexType Firma_Revisione_Type

diagram	
children	Soggetto CodiceFiscale FirmaDichiarante

element Firma_Revisione_Type/Soggetto

diagram	
type	restriction of DatoNP_Type

element Firma_Revisione_Type/CodiceFiscale

diagram	
type	DatoCF_Type

element Firma_Revisione_Type/FirmaDichiarante

diagram	
type	DatoCB_Type

complexType Firma_Type

diagram	
children	Firma CodiceFiscale

element Firma_Type/Firma

diagram	
---------	--

type	DatoCB_Type
------	-----------------------------

element **Firma_Type/CodiceFiscale**

diagram	
type	restriction of xs:string

complexType **Frontespizio_Type**

diagram	
children	SoggettoFiscale

element **Frontespizio_Type/SoggettoFiscale**

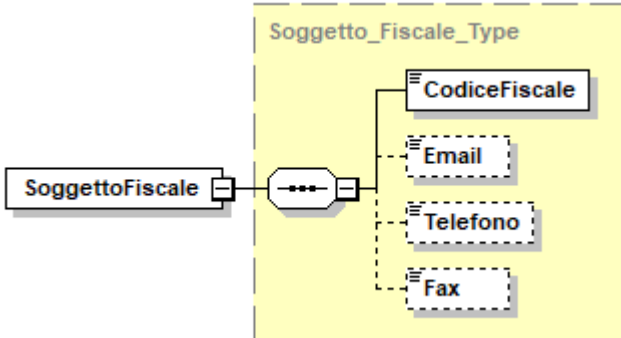
diagram	
type	Soggetto_Fiscale_Type
children	CodiceFiscale Email Telefono Fax

complexType **Impegno_A_Trasmettere_Type**

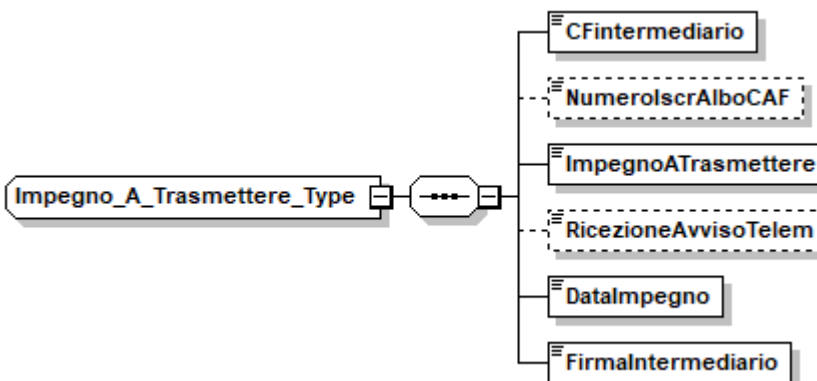
diagram	
---------	--

children	CFintermediario NumerolscrAlboCAF ImpegnoATrasmettere RicezioneAvvisoTelem DataImpegno FirmaIntermediario
----------	---

element **Impegno_A_Trasmettere_Type/CFintermediario**

diagram	
type	DatoCF_Type

element **Impegno_A_Trasmettere_Type/NumerolscrAlboCAF**

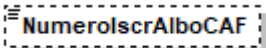
diagram	
type	restriction of DatoNU_Type

element **Impegno_A_Trasmettere_Type/ImpegnoATrasmettere**

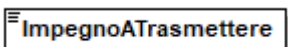
diagram							
type	restriction of DatoNP_Type						
facets	<table border="0"> <tr> <td>Kind</td> <td>Value</td> </tr> <tr> <td>enumeration</td> <td>1</td> </tr> <tr> <td>enumeration</td> <td>2</td> </tr> </table>	Kind	Value	enumeration	1	enumeration	2
Kind	Value						
enumeration	1						
enumeration	2						

element **Impegno_A_Trasmettere_Type/RicezioneAvvisoTelem**

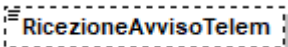
diagram	
type	DatoCB_Type

element **Impegno_A_Trasmettere_Type/DataImpegno**

diagram	
type	DatoDT_Type

element **Impegno_A_Trasmettere_Type/FirmaIntermediario**

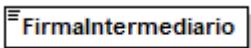
diagram	
type	DatoCB_Type

complexType **Persone_Fisiche_Type**

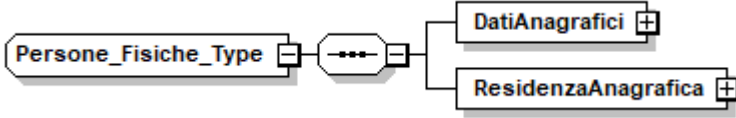
diagram	 <p>The diagram shows a box labeled 'Persone_Fisiche_Type' connected to a container symbol (a rectangle with a dashed line and three dots). This container symbol is connected to two separate boxes: 'DatiAnagrafici' and 'ResidenzaAnagrafica'. Both boxes have a small square icon with a plus sign in the top right corner, indicating they are complex types.</p>
children	<p>DatiAnagrafici ResidenzaAnagrafica</p>

element **Persone_Fisiche_Type/DatiAnagrafici**

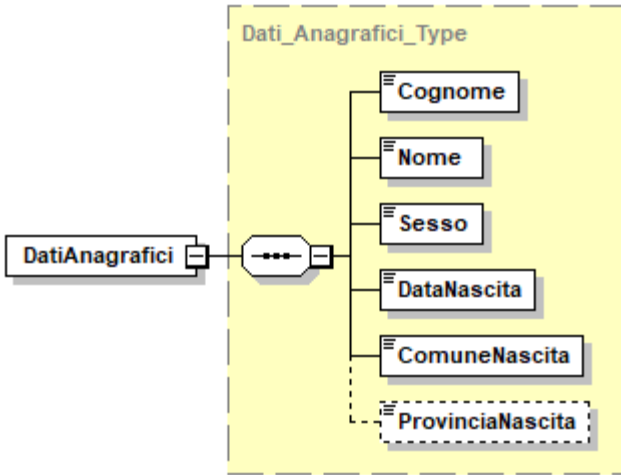
diagram	 <p>The diagram shows a box labeled 'DatiAnagrafici' connected to a container symbol. This container symbol is connected to a larger dashed box labeled 'Dati_Anagrafici_Type'. Inside this dashed box, there are five boxes: 'Cognome', 'Nome', 'Sesso', 'DataNascita', and 'ComuneNascita'. A sixth box, 'ProvinciaNascita', is shown with a dashed border, indicating it is optional. Each box has a small square icon with a plus sign in the top right corner.</p>
type	<p>Dati_Anagrafici_Type</p>
children	<p>Cognome Nome Sesso DataNascita ComuneNascita ProvinciaNascita</p>

element **Persone_Fisiche_Type/ResidenzaAnagrafica**

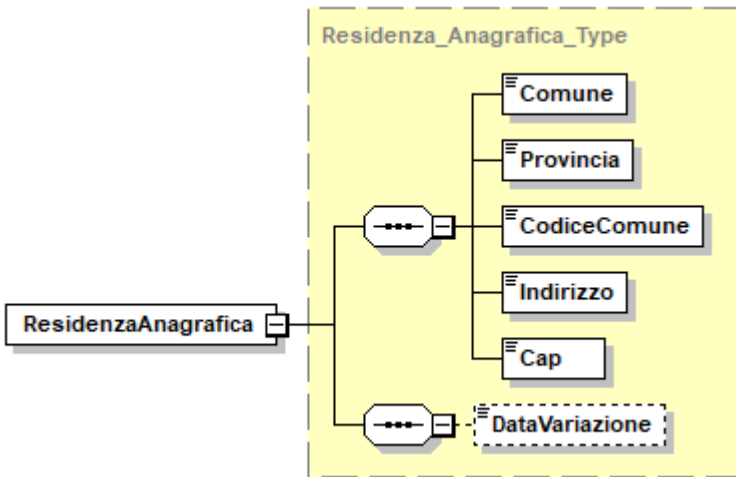
diagram	 <p>The diagram shows a box labeled 'ResidenzaAnagrafica' connected to a container symbol. This container symbol is connected to a larger dashed box labeled 'Residenza_Anagrafica_Type'. Inside this dashed box, there are five boxes: 'Comune', 'Provincia', 'CodiceComune', 'Indirizzo', and 'Cap'. A sixth box, 'DataVariazione', is shown with a dashed border, indicating it is optional. Each box has a small square icon with a plus sign in the top right corner.</p>
type	<p>Residenza_Anagrafica_Type</p>

children	Comune Provincia CodiceComune Indirizzo Cap DataVariazione
----------	--

complexType **Residenza_Anagrafica_Type**

diagram	
type	extension of Domicilio_Ita_Type
children	Comune Provincia CodiceComune Indirizzo Cap DataVariazione

element **Residenza_Anagrafica_Type/DataVariazione**

diagram	
type	DatoDT_Type

complexType **Residenza_Estera_Type**

diagram	
children	CodiceStatoEstero StatoFederato LocalitaEstero IndirizzoEstero

element **Residenza_Estera_Type/CodiceStatoEstero**

diagram	
---------	--

type	restriction of DatoAN_Type
------	--

element **Residenza_Estera_Type/StatoFederato**

diagram	
type	restriction of DatoAN_Type

element **Residenza_Estera_Type/LocalitaEstero**

diagram	
type	DatoAN_Type

element **Residenza_Estera_Type/IndirizzoEstero**

diagram	
type	DatoAN_Type

complexType **Soggetti_Diversi_Da_PF_Type**

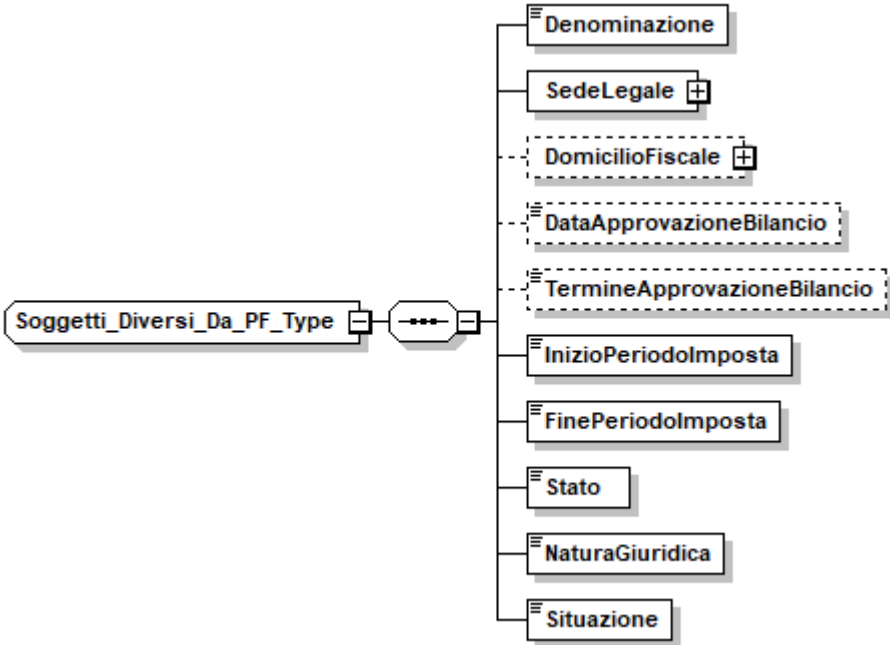
diagram	
children	Denominazione SedeLegale DomicilioFiscale DataApprovazioneBilancio TermineApprovazioneBilancio InizioPeriodoImposta FinePeriodoImposta Stato NaturaGiuridica Situazione

element **Soggetti_Diversi_Da_PF_Type/Denominazione**

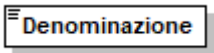
diagram	
type	DatoAN_Type

element **Soggetti_Diversi_Da_PF_Type/SedeLegale**

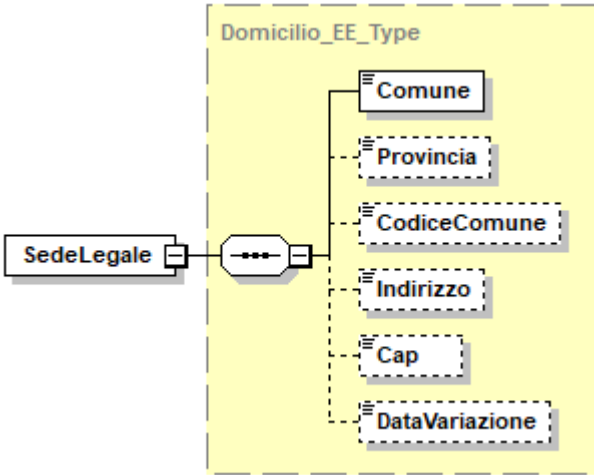
diagram	
type	Domicilio_EE_Type
children	Comune Provincia CodiceComune Indirizzo Cap DataVariazione

element **Soggetti_Diversi_Da_PF_Type/DomicilioFiscale**

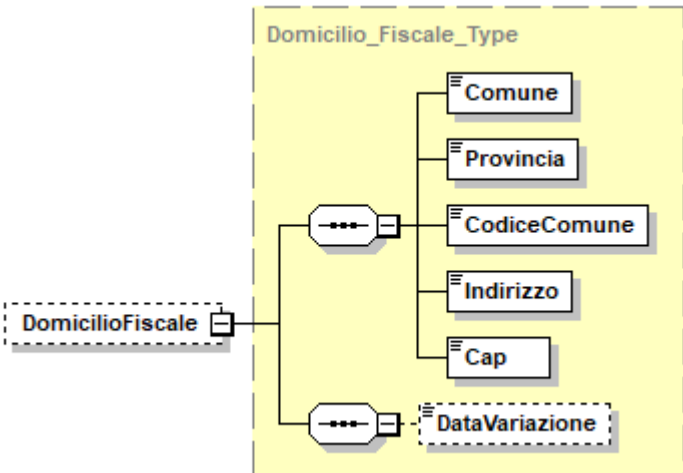
diagram	
type	Domicilio_Fiscale_Type
children	Comune Provincia CodiceComune Indirizzo Cap DataVariazione

element **Soggetti_Diversi_Da_PF_Type/DataApprovazioneBilancio**

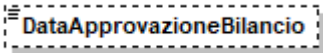
diagram	
type	DatoDT_Type

element **Soggetti_Diversi_Da_PF_Type/TermineApprovazioneBilancio**

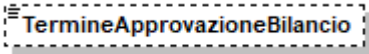
diagram	
type	DatoDT_Type

element **Soggetti_Diversi_Da_PF_Type/InizioPeriodoImposta**

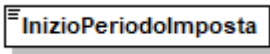
diagram	
type	DatoDT_Type

element **Soggetti_Diversi_Da_PF_Type/FinePeriodoImposta**

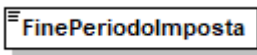
diagram	
type	DatoDT_Type

element **Soggetti_Diversi_Da_PF_Type/Stato**

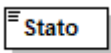
diagram											
type	Stato_Type										
facets	<table border="0"> <thead> <tr> <th>Kind</th> <th>Value</th> </tr> </thead> <tbody> <tr> <td>enumeration</td> <td>1</td> </tr> <tr> <td>enumeration</td> <td>2</td> </tr> <tr> <td>enumeration</td> <td>3</td> </tr> <tr> <td>enumeration</td> <td>4</td> </tr> </tbody> </table>	Kind	Value	enumeration	1	enumeration	2	enumeration	3	enumeration	4
Kind	Value										
enumeration	1										
enumeration	2										
enumeration	3										
enumeration	4										

element **Soggetti_Diversi_Da_PF_Type/NaturaGiuridica**

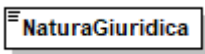
diagram							
type	Natura_Giuridica_Type						
facets	<table border="0"> <thead> <tr> <th>Kind</th> <th>Value</th> </tr> </thead> <tbody> <tr> <td>enumeration</td> <td>1</td> </tr> <tr> <td>enumeration</td> <td>2</td> </tr> </tbody> </table>	Kind	Value	enumeration	1	enumeration	2
Kind	Value						
enumeration	1						
enumeration	2						

enumeration	3
enumeration	4
enumeration	5
enumeration	6
enumeration	7
enumeration	8
enumeration	9
enumeration	10
enumeration	11
enumeration	12
enumeration	13
enumeration	14
enumeration	15
enumeration	16
enumeration	17
enumeration	18
enumeration	19
enumeration	20
enumeration	21
enumeration	22
enumeration	23
enumeration	24
enumeration	25
enumeration	26
enumeration	27
enumeration	28
enumeration	29
enumeration	30
enumeration	31
enumeration	32
enumeration	33
enumeration	34
enumeration	35
enumeration	36
enumeration	37
enumeration	38
enumeration	39
enumeration	40
enumeration	41
enumeration	42
enumeration	43
enumeration	44
enumeration	45
enumeration	50
enumeration	51
enumeration	52
enumeration	53
enumeration	54
enumeration	55
enumeration	56
enumeration	57
enumeration	58
enumeration	59

element **Soggetti_Diversi_Da_PF_Type/Situazione**

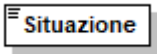
diagram		
type	Situazione Type	
facets	Kind	Value
	enumeration	1
	enumeration	2
	enumeration	3
	enumeration	4

	enumeration 5
	enumeration 6
	enumeration 7

complexType **Soggetti_Non_Residenti_Type**

diagram	
children	StatoEsteroResidenza CodiceStatoEstero CodicelIdentificazioneEstero

element **Soggetti_Non_Residenti_Type/StatoEsteroResidenza**

diagram	
type	DatoAN_Type

element **Soggetti_Non_Residenti_Type/CodiceStatoEstero**

diagram	
type	DatoAN_Type

element **Soggetti_Non_Residenti_Type/CodicelIdentificazioneEstero**

diagram	
type	DatoAN_Type

complexType **Soggetto_Fiscale_Type**

diagram	
children	CodiceFiscale Email Telefono Fax

element **Soggetto_Fiscale_Type/CodiceFiscale**

diagram	
type	DatoCF_Type

element **Soggetto_Fiscale_Type/Email**

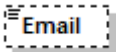
diagram	
type	DatoEM_Type

element **Soggetto_Fiscale_Type/Telefono**

diagram	
type	DatoTL_Type

element **Soggetto_Fiscale_Type/Fax**

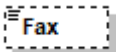
diagram	
type	DatoTL_Type

complexType **Tipo_Dichiarazione_Type**

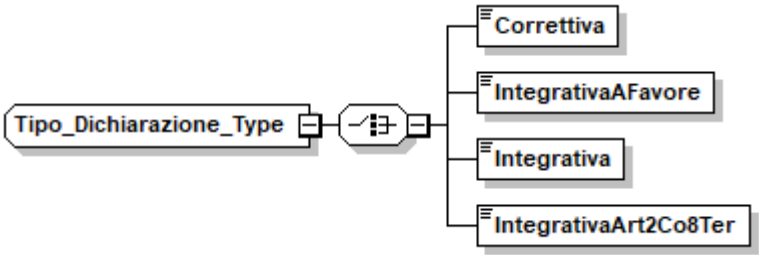
diagram	
children	Correttiva IntegrativaAFavore Integrativa IntegrativaArt2Co8Ter

element **Tipo_Dichiarazione_Type/Correttiva**

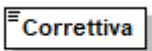
diagram	
type	DatoCB_Type

element **Tipo_Dichiarazione_Type/IntegrativaAFavore**

diagram	
type	DatoCB_Type

element **Tipo_Dichiarazione_Type/Integrativa**

diagram	
type	DatoCB_Type

element **Tipo_Dichiarazione_Type/IntegrativaArt2Co8Ter**

diagram	
type	DatoCB_Type

complexType **Visto_Conformita_Type**

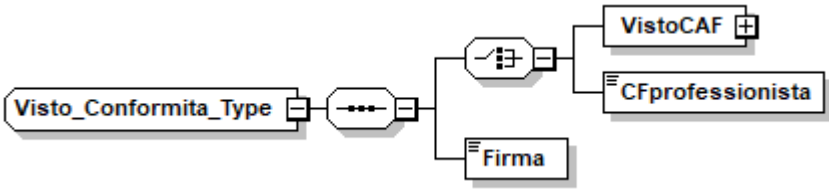
diagram	
children	VistoCAF CFprofessionista Firma

element **Visto_Conformita_Type/VistoCAF**

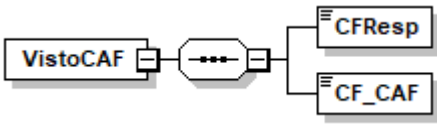
diagram	
children	CFResp CF_CAF

element **Visto_Conformita_Type/VistoCAF/CFResp**

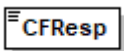
diagram	
type	DatoCF_Type

element **Visto_Conformita_Type/VistoCAF/CF_CAF**

diagram	
type	DatoCN_Type

element **Visto_Conformita_Type/CFprofessionista**

diagram	
type	DatoCF_Type

element **Visto_Conformita_Type/Firma**

diagram	
type	DatoCB_Type

simpleType **Estero**

type	restriction of xs:string				
facets	<table border="1"> <thead> <tr> <th>Kind</th> <th>Value</th> </tr> </thead> <tbody> <tr> <td>enumeration</td> <td>EE</td> </tr> </tbody> </table>	Kind	Value	enumeration	EE
Kind	Value				
enumeration	EE				

simpleType **PE_Type**

type	union of (ProvinciItaliane , Estero)
------	--

simpleType **PN_Type**

type	union of (ProvinciItaliane , ProvinciaCroate , Estero , ProvinciaSoppresse)
------	---

simpleType **PR_Type**

type	union of (ProvinciItaliane)
------	---

simpleType **ProvinciaCroate**

type	restriction of xs:string								
facets	<table border="1"> <thead> <tr> <th>Kind</th> <th>Value</th> </tr> </thead> <tbody> <tr> <td>enumeration</td> <td>FU</td> </tr> <tr> <td>enumeration</td> <td>PL</td> </tr> <tr> <td>enumeration</td> <td>ZA</td> </tr> </tbody> </table>	Kind	Value	enumeration	FU	enumeration	PL	enumeration	ZA
Kind	Value								
enumeration	FU								
enumeration	PL								
enumeration	ZA								

simpleType **ProvinciItaliane**

type	restriction of xs:string	
facets	Kind	Value
	enumeration	AG
	enumeration	AL
	enumeration	AN
	enumeration	AO
	enumeration	AP
	enumeration	AQ
	enumeration	AR
	enumeration	AT
	enumeration	AV
	enumeration	BA
	enumeration	BG
	enumeration	BI
	enumeration	BL
	enumeration	BN
	enumeration	BO
	enumeration	BR
	enumeration	BS
	enumeration	BT
	enumeration	BZ
	enumeration	CA
	enumeration	CB
	enumeration	CE
	enumeration	CH
	enumeration	CI
	enumeration	CL
	enumeration	CN
	enumeration	CO
	enumeration	CR
	enumeration	CS
	enumeration	CT
	enumeration	CZ
	enumeration	EN
	enumeration	FC
	enumeration	FE
	enumeration	FG
	enumeration	FI
	enumeration	FM
	enumeration	FR
	enumeration	GE
	enumeration	GO
	enumeration	GR
	enumeration	IM
	enumeration	IS
	enumeration	KR
	enumeration	LC
	enumeration	LE
	enumeration	LI
	enumeration	LO
	enumeration	LT
	enumeration	LU
	enumeration	MB
	enumeration	MC
	enumeration	ME
	enumeration	MI
	enumeration	MN
	enumeration	MO
	enumeration	MS
	enumeration	MT
	enumeration	NA
	enumeration	NO
	enumeration	NU
	enumeration	OG

enumeration	OR
enumeration	OT
enumeration	PA
enumeration	PC
enumeration	PD
enumeration	PE
enumeration	PG
enumeration	PI
enumeration	PN
enumeration	PO
enumeration	PR
enumeration	PT
enumeration	PU
enumeration	PV
enumeration	PZ
enumeration	RA
enumeration	RC
enumeration	RE
enumeration	RG
enumeration	RI
enumeration	RM
enumeration	RN
enumeration	RO
enumeration	SA
enumeration	SI
enumeration	SO
enumeration	SP
enumeration	SR
enumeration	SS
enumeration	SU
enumeration	SV
enumeration	TA
enumeration	TE
enumeration	TN
enumeration	TO
enumeration	TP
enumeration	TR
enumeration	TS
enumeration	TV
enumeration	UD
enumeration	VA
enumeration	VB
enumeration	VC
enumeration	VE
enumeration	VI
enumeration	VR
enumeration	VS
enumeration	VT
enumeration	VV

simpleType ProvincieSoppresse

type	restriction of xs:string						
facets	<table border="1"> <thead> <tr> <th>Kind</th> <th>Value</th> </tr> </thead> <tbody> <tr> <td>enumeration</td> <td>FO</td> </tr> <tr> <td>enumeration</td> <td>PS</td> </tr> </tbody> </table>	Kind	Value	enumeration	FO	enumeration	PS
Kind	Value						
enumeration	FO						
enumeration	PS						

simpleType Casella_Quadro_Type

type	restriction of DatoAN_Type						
facets	<table border="1"> <thead> <tr> <th>Kind</th> <th>Value</th> </tr> </thead> <tbody> <tr> <td>enumeration</td> <td>0</td> </tr> <tr> <td>enumeration</td> <td>1</td> </tr> </tbody> </table>	Kind	Value	enumeration	0	enumeration	1
Kind	Value						
enumeration	0						
enumeration	1						

	enumeration 2
	enumeration 3

simpleType Codice_Carica_Type

type	restriction of DatoNP_Type	
facets	Kind	Value
	enumeration	1
	enumeration	2
	enumeration	3
	enumeration	4
	enumeration	5
	enumeration	6
	enumeration	7
	enumeration	8
	enumeration	9
	enumeration	10
	enumeration	11
	enumeration	12
	enumeration	13
	enumeration	14
	enumeration	15

simpleType Codice_Regione_Type

type	restriction of DatoAN_Type	
facets	Kind	Value
	enumeration	1
	enumeration	2
	enumeration	3
	enumeration	4
	enumeration	5
	enumeration	6
	enumeration	7
	enumeration	8
	enumeration	9
	enumeration	10
	enumeration	11
	enumeration	12
	enumeration	13
	enumeration	14
	enumeration	15
	enumeration	16
	enumeration	17
	enumeration	18
	enumeration	19
	enumeration	20
	enumeration	21

simpleType Natura_Giuridica_Type

type	restriction of DatoNP_Type	
facets	Kind	Value
	enumeration	1
	enumeration	2
	enumeration	3
	enumeration	4
	enumeration	5
	enumeration	6
	enumeration	7
	enumeration	8

enumeration	9
enumeration	10
enumeration	11
enumeration	12
enumeration	13
enumeration	14
enumeration	15
enumeration	16
enumeration	17
enumeration	18
enumeration	19
enumeration	20
enumeration	21
enumeration	22
enumeration	23
enumeration	24
enumeration	25
enumeration	26
enumeration	27
enumeration	28
enumeration	29
enumeration	30
enumeration	31
enumeration	32
enumeration	33
enumeration	34
enumeration	35
enumeration	36
enumeration	37
enumeration	38
enumeration	39
enumeration	40
enumeration	41
enumeration	42
enumeration	43
enumeration	44
enumeration	45
enumeration	50
enumeration	51
enumeration	52
enumeration	53
enumeration	54
enumeration	55
enumeration	56
enumeration	57
enumeration	58
enumeration	59

simpleType Sesso_Type

type	restriction of DatoAN_Type						
facets	<table border="0"> <tr><td>Kind</td><td>Value</td></tr> <tr><td>enumeration</td><td>M</td></tr> <tr><td>enumeration</td><td>F</td></tr> </table>	Kind	Value	enumeration	M	enumeration	F
Kind	Value						
enumeration	M						
enumeration	F						

simpleType Situazione_Type

type	restriction of DatoNP_Type										
facets	<table border="0"> <tr><td>Kind</td><td>Value</td></tr> <tr><td>enumeration</td><td>1</td></tr> <tr><td>enumeration</td><td>2</td></tr> <tr><td>enumeration</td><td>3</td></tr> <tr><td>enumeration</td><td>4</td></tr> </table>	Kind	Value	enumeration	1	enumeration	2	enumeration	3	enumeration	4
Kind	Value										
enumeration	1										
enumeration	2										
enumeration	3										
enumeration	4										

	enumeration 5
	enumeration 6
	enumeration 7

simpleType **Stato_Type**

type	restriction of DatoNP_Type										
facets	<table border="1"> <thead> <tr> <th>Kind</th> <th>Value</th> </tr> </thead> <tbody> <tr> <td>enumeration</td> <td>1</td> </tr> <tr> <td>enumeration</td> <td>2</td> </tr> <tr> <td>enumeration</td> <td>3</td> </tr> <tr> <td>enumeration</td> <td>4</td> </tr> </tbody> </table>	Kind	Value	enumeration	1	enumeration	2	enumeration	3	enumeration	4
Kind	Value										
enumeration	1										
enumeration	2										
enumeration	3										
enumeration	4										

simpleType **Eventi_Ecc_Type**

type	restriction of xs:string										
facets	<table border="1"> <thead> <tr> <th>Kind</th> <th>Value</th> </tr> </thead> <tbody> <tr> <td>enumeration</td> <td>1</td> </tr> <tr> <td>enumeration</td> <td>2</td> </tr> <tr> <td>enumeration</td> <td>3</td> </tr> <tr> <td>enumeration</td> <td>4</td> </tr> </tbody> </table>	Kind	Value	enumeration	1	enumeration	2	enumeration	3	enumeration	4
Kind	Value										
enumeration	1										
enumeration	2										
enumeration	3										
enumeration	4										

DESCRIZIONE DEI CODICI PRESENTI NELLA FORNITURA P7324, RELATIVI ALL'ESITO DELLA RICHIESTA DI MOD. 730 PRECOMPILATI TRAMITE FILE	
MODELLO 730 PRECOMPILATO PRESENTE NELLA FORNITURA P7324	
Valori dell'elemento "stato" presente in "EsitoRichiesta" del file xml di fornitura P7324	Descrizione
300	Per il codice fiscale del contribuente è presente il 730 Precompilato con il relativo prospetto di liquidazione
310	Per il codice fiscale del contribuente è presente il 730 Precompilato ma non è liquidabile
320	Per il codice fiscale del contribuente è presente il 730 Precompilato con il relativo prospetto di liquidazione. La dichiarazione precompilata è relativa ad un soggetto deceduto
330	Per il codice fiscale del contribuente è presente il 730 Precompilato ma non è liquidabile. La dichiarazione precompilata è relativa ad un soggetto deceduto
MODELLO 730 PRECOMPILATO NON PRESENTE NELLA FORNITURA P7324	
Valori dell'elemento "stato" presente in "EsitoRichiesta" del file xml di fornitura P7324	Descrizione
055, 355	Il codice fiscale del contribuente non è valido
056	Il codice fiscale del contribuente non è associato ad una persona fisica
057, 357	Il codice fiscale del contribuente non è utilizzabile in quanto aggiornato in altro codice fiscale (*)
064, 065	Per il codice fiscale del contribuente non risulta presentata alcuna dichiarazione 730/2023 o Redditi PF/2023 congruente con gli importi indicati nella richiesta
066	Per il codice fiscale del contribuente risulta presentata una dichiarazione 730/2023 o Redditi PF/2023 e risulta compilato il flag "Assenza di dichiarazione presentata "
067	Per il codice fiscale del contribuente il 730 Precompilato è in corso di elaborazione
307	Per il codice fiscale del contribuente non è stato predisposto il 730 Precompilato
308, 311	Per il codice fiscale del contribuente il 730 Precompilato non è disponibile. Per le motivazioni consultare il sito di Assistenza https://assistenza.agenziaentrate.gov.it

058	Per il codice fiscale del contribuente il 730 Precompilato non è disponibile in quanto per il codice fiscale del contribuente non risulta trasmessa nei termini, dal sostituto d'imposta (soggetto richiedente) all'Agenzia delle entrate, la Certificazione Unica 2024 per redditi di lavoro dipendente
068	Per il codice fiscale del contribuente il 730 Precompilato non è disponibile in quanto il soggetto richiedente non ha una delega valida a richiederlo
Nota (*) Il codice fiscale indicato non è utilizzabile perché è un cosiddetto "omocodice", cioè corrispondente ai dati anagrafici di diverse persone. L'Agenzia delle Entrate ha quindi attribuito un nuovo codice fiscale, differente, a ciascuna di esse. Il nuovo codice fiscale è stato comunicato alle persone interessate ed è quello che va utilizzato.	

La situazione in cui ad una stessa descrizione corrispondono due distinti codici, nella generalità dei casi, fa riferimento ai diversi momenti nei quali è stata riscontrata l'anomalia (acquisizione della richiesta ovvero predisposizione della fornitura).